

ILLUSTRATED PARTS LIST

CUSTOMER MODEL NO. PRRT850

MFG ID NO. 96092001304

TILLER - - MODEL NUMBER PRRT850 (96092001304)

HANDLE ASSEMBLY

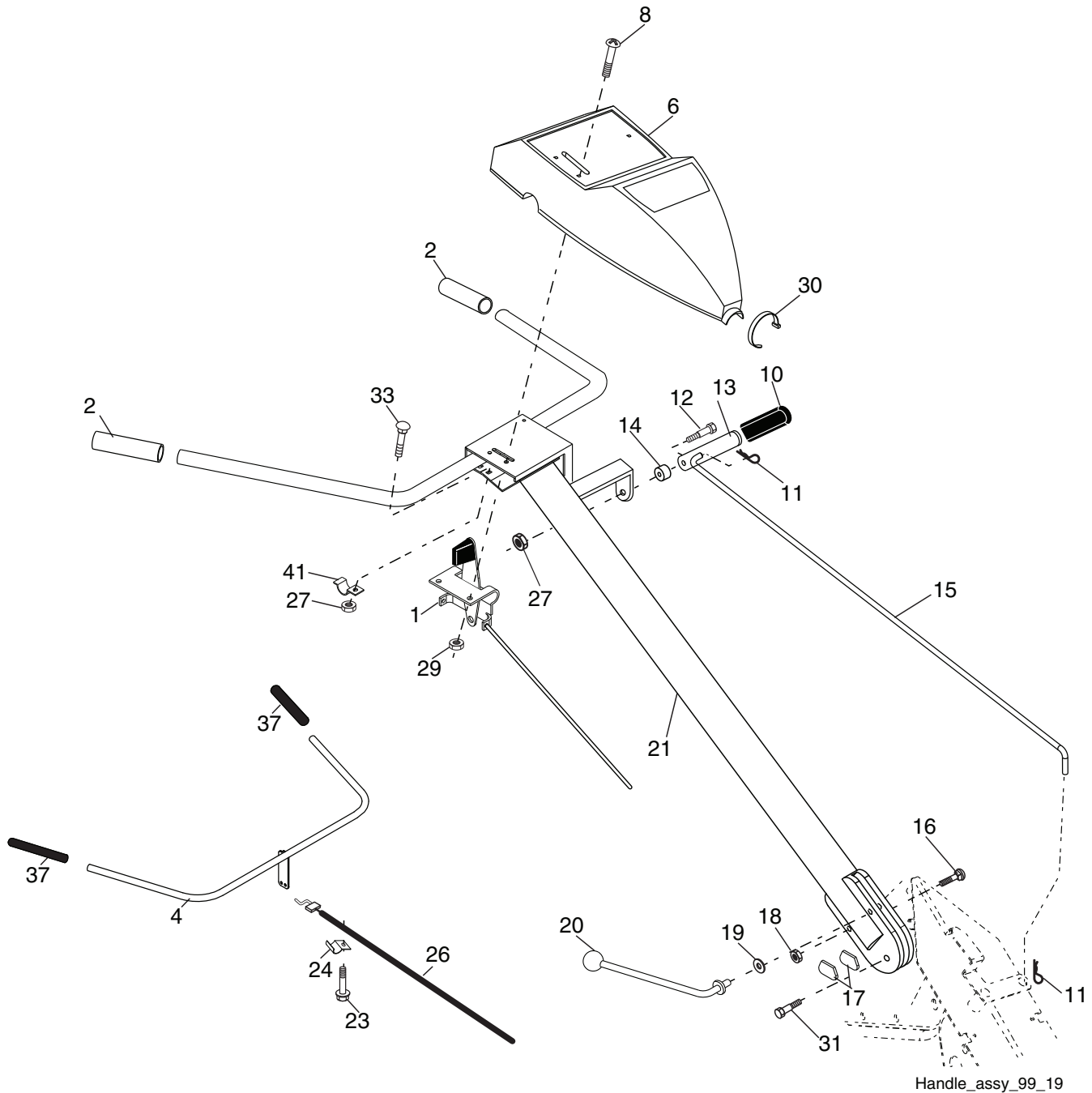

KEY NO.	PART NO.	DESCRIPTION
1	189482	Control, Throttle
2	427643	Grip, Handle
4	159228	Bar Assembly, Control
6	180678	Panel, Control
8	71191008	Screw, Phd. #10-24
10	8206H	Grip, Handle
11	4497H	Clip, Hairpin
12	81328	Bolt, Shoulder
13	187497	Handle, Shift
14	109313X	Grommet, Rubber
15	109337X	Rod, Shift
16	72110608	Bolt, Carriage 3/8-16 x 1 Gr. 5
17	109229X	Lock, Handle
18	73680600	Nut, Crownlock 3/8-16 unc
19	19131611	Washer 13/32 x 1 x 11 Ga.
20	109228X	Lever, Lock, Handle

KEY NO.	PART NO.	DESCRIPTION
21	180517X428	Handle
23	86777	Screw, Hex Washer Hd. Slotted #10-24 x 1/2
24	9484R	Clip
26	159231	Cable, Clutch
27	73900400	Nut Hex Flange 1/4-20 unc
29	73731000	Nut, Keps #10-24 unc
30	104164X	Tie, Cable
31	150696	Bolt, Pivot
33	72140404	Bolt, Carriage 1/4-20 unc x 1/2
37	102604X	Grip, Bar, Control
41	102744X	Clamp, Bar, Control

NOTE: All component dimensions given in U.S. inches.
1 inch = 25.4 mm

TILLER - - MODEL NUMBER PRRT850 (96092001304)

MAINFRAME, LEFT SIDE

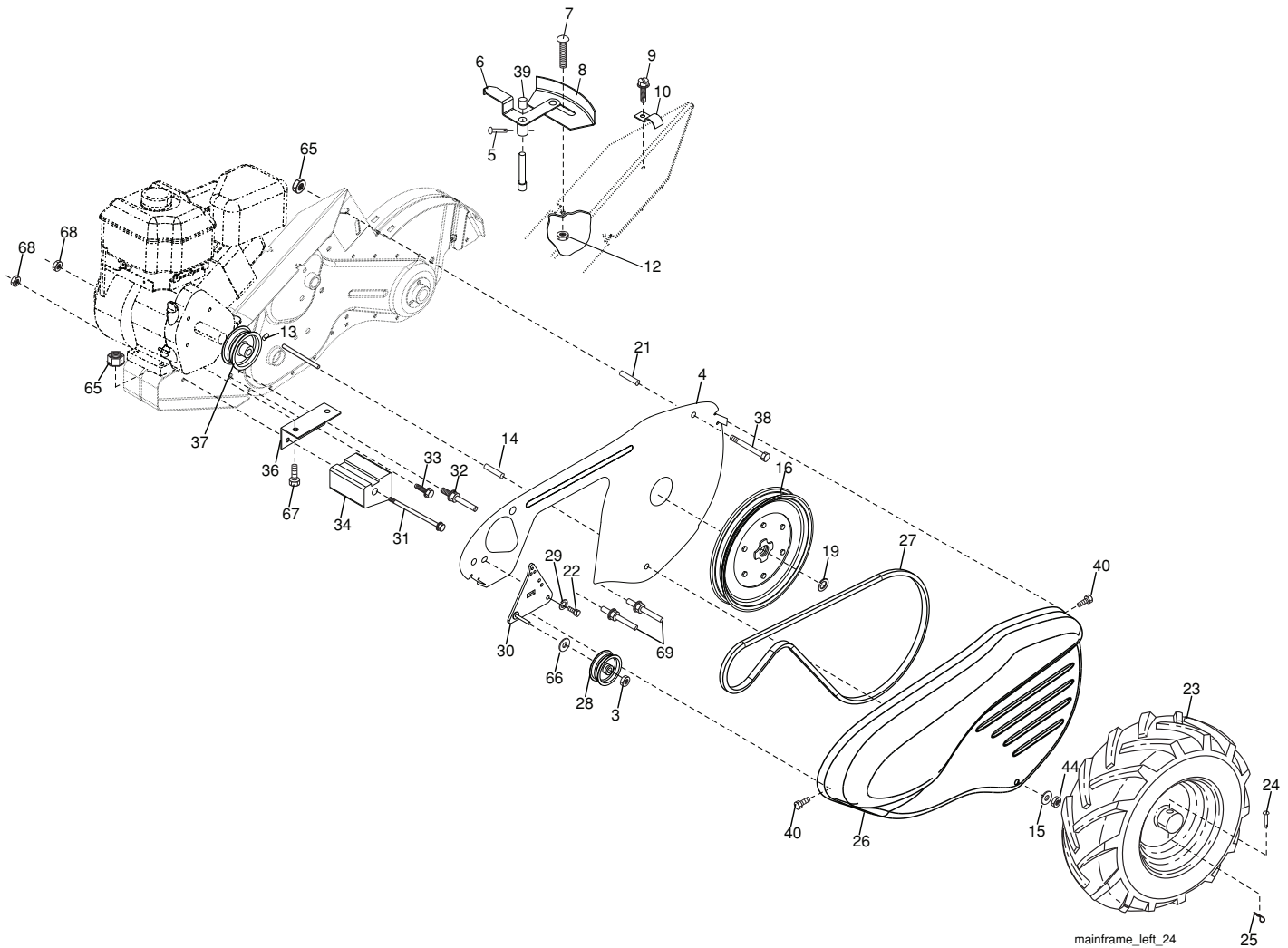

KEY NO.	PART NO.	DESCRIPTION
3	73220600	Nut, Hex 3/8-16
4	432420	Shield, Inner Belt Guard RT
5	164329	Screw, Shift Lever
6	110111X	Lever, Shift
7	72110404	Bolt, Carriage 1/4-20 x 1/2 Gr. 5
8	8700J	Plate, Shift Indicator
9	86777	Screw, Hex, Washer Head, Slotted #10-24 x 1/2
10	9484R	Clip
12	73510400	Nut, Keps Hex 1/4-20 unc
13	23230506	Screw, Set, Hex 5/16-18 x 3/8
14	156117	Spacer, Split 0.327 x 0.42 x 1.220
15	19111116	Washer 11/32 x 11/16 x 16 Ga.
16	145102	Sheave, Transmission
19	12000028	Retainer, Ring
21	110652X	Spacer, Split 0.327 x 0.42 x 2.09
22	74770508	Bolt, Fin Hex 5/16-24 unf x 1/2
23	5015J	Tire
	127259X	Rim
	795R	Tire Valve
24	126875X	Rivet, Drilled
25	4497H	Clip, Hairpin
26	165501X428	Guard, Belt

KEY NO.	PART NO.	DESCRIPTION
27	132801	Belt, V
28	104679X	Pulley, Idler
29	12000032	Ring, Klip
30	159229	Bracket, Idler
31	102384X	Bolt, Hex 5/16-16 x 12
32	102141X	Shaft, Idler Arm
33	74760616	Bolt, Hex 3/8-16 x 1
34	102383X	Counterweight, L. H.
35	74760528	Bolt, Hex 5/16-18 x 1-3/4
36	102331X	Bracket, Reinforcement, L. H.
37	130812	Sheave, Engine
38	74760544	Bolt, Fin Hex 5/16-18 unc x 2-3/4
39	140062	Cap, Plunger Blk
40	170488	Screw Hex Wsh Slit #10-24 x 1/2
44	73800500	Nut Lock Hex w/Ins 5/16-18 unc PL
65	73970500	Nut Lock Hex Flange
66	19131312	Washer 13/32 x 13/16 x 12 Ga.
68	73510600	Nut Keps Hex 3/8-16 unc
69	164173	Keeper Belt Engine

NOTE: All component dimensions given in U.S. inches. 1 inch = 25.4 mm

TILLER - - MODEL NUMBER PRRT850 (96092001304)
MAINFRAME, RIGHT SIDE

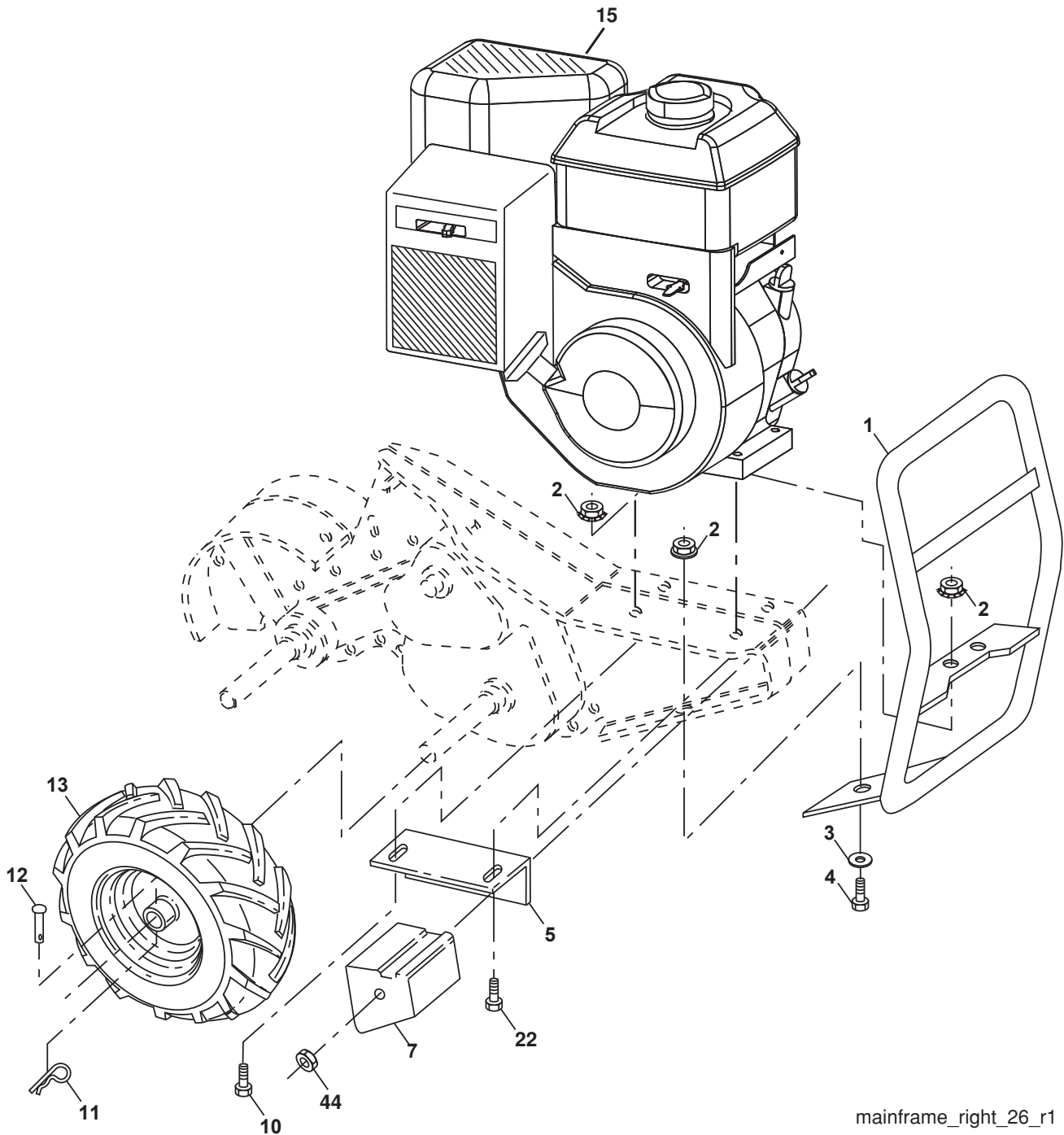

mainframe_right_26_r1

KEY NO.	PART NO.	DESCRIPTION
1	185190	Bumper
2	73970500	Locknut, Hex, Flange 5/16-18
3	19111116	Washer 11/32 x 11/16 x 16 Ga.
4	74760512	Bolt, Hex 5/16-18 x 3/4
5	102332X	Bracket, Reinforcement
7	102173X	Counter Weight, R.H.
10	74760524	Bolt, Hex 5/16-18 x 1-1/2
11	4497H	Clip, Hairpin
12	126875X	Rivet, Drilled

KEY NO.	PART NO.	DESCRIPTION
13	5015J 127259X 795R	Tire Rim Tire Valve
15	-----	Engine, Briggs & Stratton Model No. 157202 (Order parts from engine manufacturer)
22	74760528	Bolt, Hex 5/16-18 x 1-3/4
44	73510600	Nut, Keps, Hex 3/8-16 unc

NOTE: All component dimensions given in U.S.inches.
 1 inch = 25.4 mm

TILLER - - MODEL NUMBER PRRT850 (96092001304)

TRANSMISSION

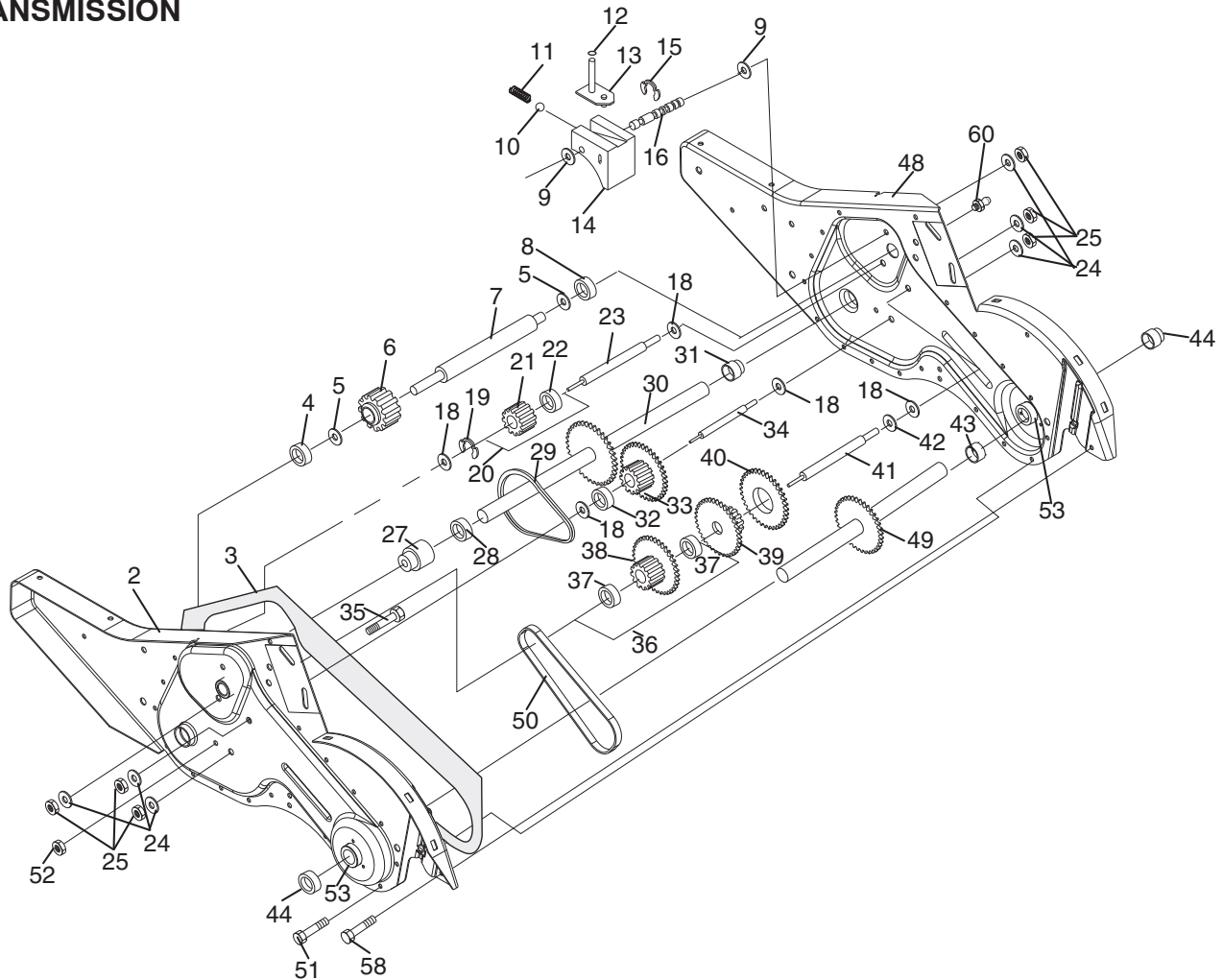

KEY NO.	PART NO.	DESCRIPTION	KEY NO.	PART NO.	DESCRIPTION
1	188554	Transmission Assembly (Includes Key Nos. 2-53)	29	102134X	Chain #35-50 Pitch
2	188482	Gearcase, L.H. w/Bearing (Includes Key No. 4)	30	150737	Ground Shaft Assembly
3	161963	Gasket, Gearcase	31	143008	Bearing, Shaft, Ground Drive R.H.
4	5020J	Bearing, Needle	32	106388X	Spacer 0.70 x 1.00 x 1.150
5	1370H	Washer, Thrust 5/8 x 1.10 x 1/32	33	102121X	Sprocket and Gear Assembly
6	137335	Pinion, Input	34	102112X	Shaft, Reduction (2nd)
7	145101	Shaft, Input	35	102101X	Screw, Whiz, Lock 5/16-18 x 3-1/2
8	4895H	Bearing, Needle	36	154355	Sprocket Assembly w/Bearing (Includes Key Nos. 37 and 38)
9	154467	Washer, Seal	37	4422J	Bearing, Needle
10	7392M	Ball, Steel	38	154356	Sprocket, Tine
11	100371K	Spring, Shift, Fork	39	105345X	Gear, Cluster, Red 1st & 2nd
12	106160X	O-Ring	40	105346X	Gear, Reverse
13	142145	Asm. Bracket Shift	41	8358J	Shaft, Reduction (1st)
14	8353J	Fork, Shift	42	4220R	Washer, Thrust
15	12000039	Ring, Klip	43	106146X	Spacer 1.01 x 1.75 x 0.760
16	154466	Shaft, Shift	44	155236	Seal Asm, Oil
18	4358J	Washer	48	188485	Gearcase, R.H. w/Bearing (Includes Key No. 8)
19	12000040	Ring, Klip	49	132688	Shaft, Tine
20	102114X	Gear, Assembly, Reverse Idler (Includes Key Nos. 21 and 22)	50	106147X	Chain, Roller #50-50 Pitch
21	102115X	Gear, Reverse Idler	51	17720408	Screw 1/4-20 x 1/2
22	6803J	Bearing, Needle	52	73220500	Nut, Hex 5/16-18
23	102111X	Shaft, Reverse Idler	53	165140	Kit, Bearing
24	10040700	Washer, Lock 7/16	58	179520	Bolt Shoulder
25	73610700	Nut, Hex 7/16-20	60	183226	Fitting Grease
27	143009	Bearing, Shaft, Ground Drive L.H.	--	6066J	Grease, Plastilube #1
28	106390X	Spacer 0.765 x 1.125 x 1.23			

NOTE: All component dimensions given in U.S. inches.
1 inch = 25.4 mm

TILLER - - MODEL NUMBER PRRT850 (96092001304)

TINE SHIELD

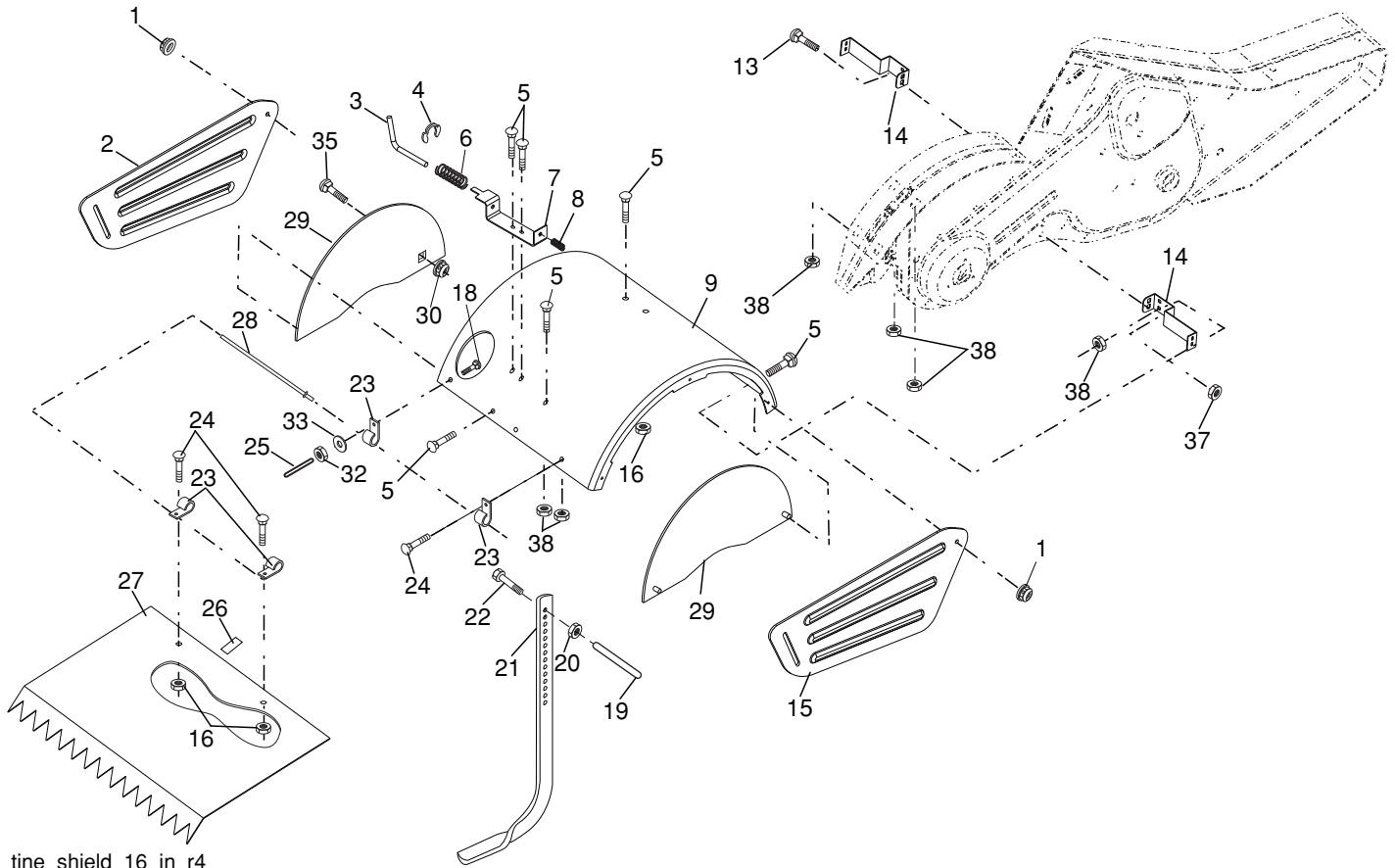

tine_shield_16_in_r4

KEY NO.	PART NO.	DESCRIPTION
1	73900500	Nut, Lock Hex Flange 5/16-18
2	161415X428	Shield, Side, Outer L. H.
3	8393J	Pin, Stake, Depth
4	12000035	Ring, Klip
5	180847	Bolt 5/16-18 x 3/4 ZNC
6	8394J	Spring
7	8392J	Bracket, Latch
8	109230X	Spring, Depth Stake
9	124289X428	Shield, Tine
13	72110510	Bolt, Carriage 5/16-18 x 1-1/4
14	124311X	Bracket, Shield Tine
15	161414X428	Shield, Side, Outer R.H.
16	73900400	Nut, Hex Flange 1/4-20 unc
18	72040410	Bolt, Carriage 1/4-20 x 1-1/4 Gr. 5
19	102701X	Grip
20	73220600	Nut, Hex 3/8-16
21	102156X	Stake, Depth

KEY NO.	PART NO.	DESCRIPTION
22	74930632	Bolt, Hex 3/8-16 x 2
23	4440J	Hinge
24	72140404	Bolt, Carriage 1/4-20 x 1/2 Gr. 5
25	6712J	Cap, Vinyl
26	109227X	Pad, Idler
27	102695X428	Shield, Leveling
28	120588X	Pin, Hinge
29	197761X428	Shield, Side
30	73970500	Locknut, Flange 5/16-18
32	73220400	Nut Fin Hex 1/4-20 unc
33	10040400	Washer Lock Hvy Helical 1/4
35	72110505	Bolt, Carriage 5/16-18 x 5/8
37	73800500	Nut, Lock Hex 5/16-18 unc
38	73510500	Nut, Keps 5/16-18 unc

NOTE: All component dimensions given in U.S. inches.
1 inch = 25.4 mm

TILLER - - MODEL NUMBER PRRT850 (96092001304)

TINE ASSEMBLY

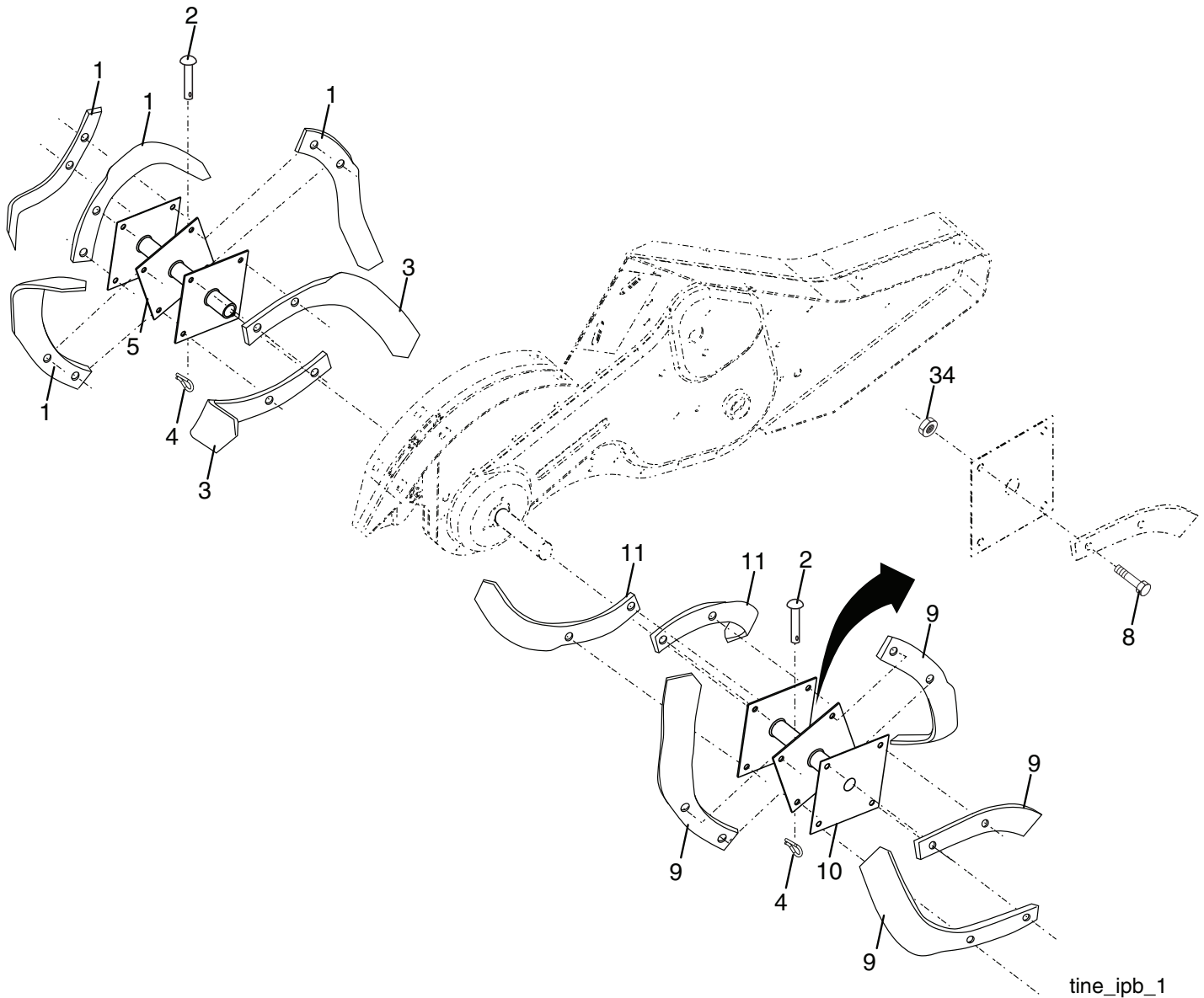

tine_ipb_1

KEY NO.	PART NO.	DESCRIPTION
1	4459J	Tine, Outer, L.H.
2	132673	Clevis Pin
3	6554J	Tine, Inner, L.H.
4	3146R	Retainer, Spring Zinc
5	132727	Assembly, Hub and Plate, L.H.
8	74610616	Bolt, Hex 3/8-24 x 1
9	4460J	Tine, Outer, R.H.

KEY NO.	PART NO.	DESCRIPTION
10	132728	Assembly, Hub and Plate, R.H.
11	6555J	Tine, Inner, R.H.
34	73540600	Nut Crownlock 3/8-24

NOTE: All component dimensions given in U.S. inches.
1 inch = 25.4 mm

TILLER - - MODEL NUMBER PRRT850 (96092001304)

DECALS

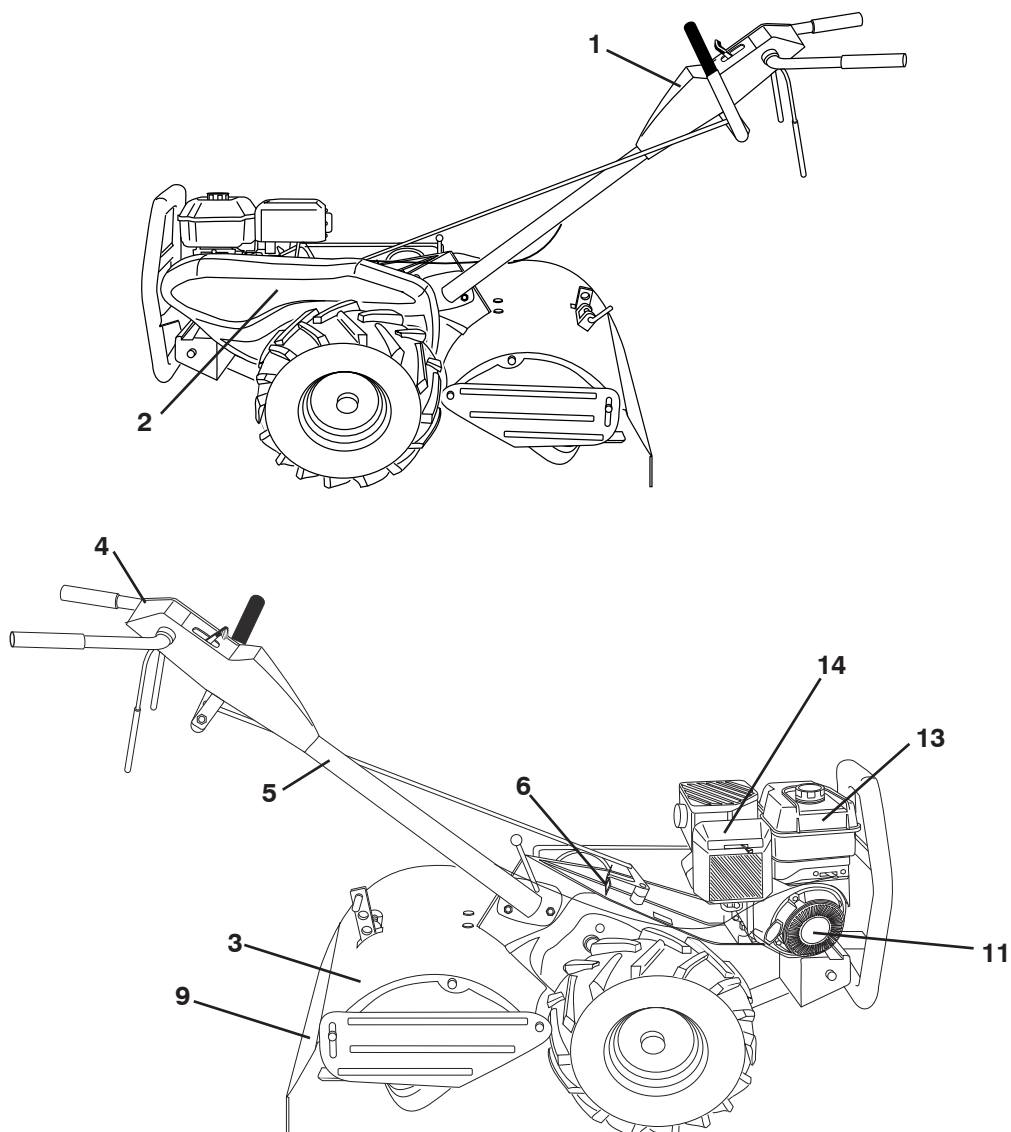

KEY NO.	PART NO.	DESCRIPTION
1	173196	Decal, CNTRL PNL
2	417934	Decal, Blt Grd
3	422972	Decal, Warning
4	180816	Decal, Instruction, Tilling
5	110614X	Decal, Hand Placement
6	102180X	Decal, Shift Indicator
7	162384	Decal, Caution
9	120076X	Decal, Warning, Rotating Tines
11	411816	Decal, Rewind
13	417548	Decal, B&S Tank
14	418797	Decal, B&S, Air Cleaner
--	417150	Manual, Operator's, English/French
--	427553	Manual, Repair Parts, English/French