

REPAIR PARTS MANUAL
MODEL NO. PR600Y22SHP
MFG. ID. NO. 96122001404
Rotary Lawn Mower

For Parts and Service, contact our authorized distributor: call 1-800-849-1297
For Technical Assistance: call 1-800-829-5886

Poulan PRO

Poulan PRO

419899 02.22.08 BY

Printed in U.S.A.

ROTARY LAWN MOWER - - MODEL NUMBER PR600Y22SHP (MFG. ID. NUMBER 96122001404)

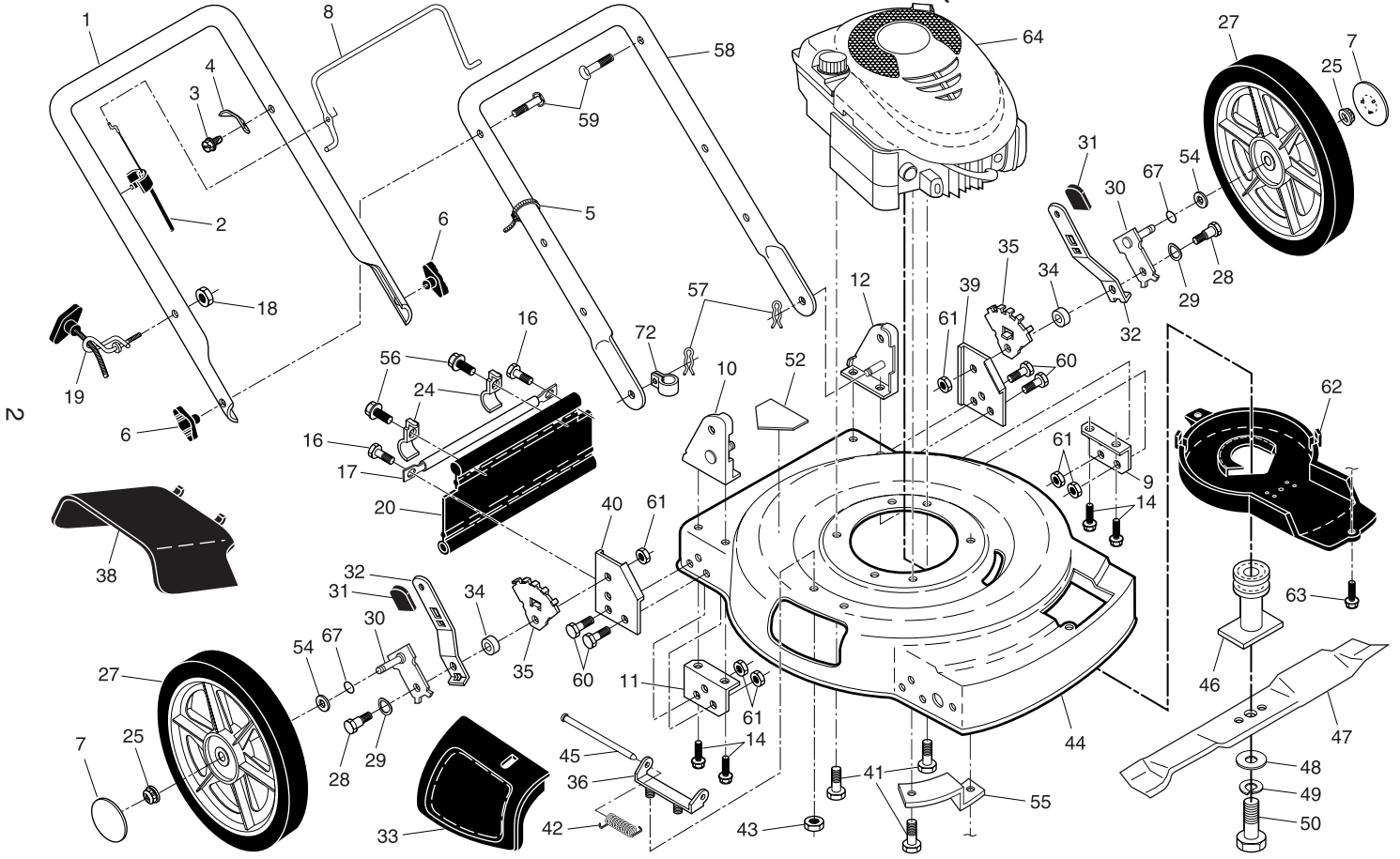

2

7

SERVICE NOTES

LIMITED WARRANTY

The Manufacturer warrants to the original consumer purchaser that this product as manufactured is free from defects in materials and workmanship. For a period of two (2) years from date of purchase by the original consumer purchaser, we will repair or replace, at our option, without charge for parts or labor incurred in replacing parts, any part which we find to be defective due to materials or workmanship. This Warranty is subject to the following limitations and exclusions.

1. This warranty does not apply to the engine, transaxle/transmission components, battery (except as noted below) or components parts thereof. Please refer to the applicable manufacturer's warranty on these items.
2. Transportation charges for the movement of any power equipment unit or attachment are the responsibility of the purchaser. Transportation charges for any parts submitted for replacement under this warranty must be paid by the purchaser unless such return is requested by the manufacturer.
3. Battery Warranty: On products equipped with a Battery, we will replace, without charge to you, any battery which we find to be defective in manufacture, during the first ninety (90) days of ownership. After ninety (90) days, we will exchange the Battery, charging you 1/12 of the price of a new Battery for each full month from the date of the original sale. Battery must be maintained in accordance with the instructions furnished.
4. The Warranty period for any products used for rental or commercial purposes is limited to 45 days from the date of original purchase.
5. This Warranty applies only to products which have been properly assembled, adjusted, operated, and maintained in accordance with the instructions furnished. This Warranty does not apply to any product which has been subjected to alteration, misuse, abuse, improper assembly or installation, delivery damage, or to normal wear of the product.
6. Exclusions: Excluded from this Warranty are belts, blades, blade adapters, normal wear, normal adjustments, standard hardware and normal maintenance.
7. In the event you have a claim under this Warranty, you must return the product to an authorized service dealer.

Should you have any unanswered questions concerning this Warranty, contact:

Poulan Pro
Customer Service Department
1030 Stevens Creek Road
Augusta, GA 30907 USA

In Canada contact:
Poulan Pro
Customer Service Department
5855 Terry Fox Way
Mississauga, Ontario L5V 3E4

giving the model number, serial number and date of purchase of your product and the name and address of the authorized dealer from whom it was purchased. THIS WARRANTY DOES NOT APPLY TO INCIDENTAL OR CONSEQUENTIAL DAMAGES AND ANY IMPLIED WARRANTIES ARE LIMITED TO THE SAME TIME PERIODS STATED HEREIN FOR OUR EXPRESSED WARRANTIES. Some areas do not allow the limitation of consequential damages or limitations of how long an implied Warranty may last, so the above limitations or exclusions may not apply to you. This Warranty gives you specific legal rights, and you may have other rights which vary from locale to locale. This is a limited Warranty within the meaning of that term as defined in the Magnuson-Moss Act of 1975.

ROTARY LAWN MOWER - - MODEL NUMBER PR600Y22SHP (MFG. ID. NUMBER 96122001404)

KEY NO.	PART NO.	DESCRIPTION	KEY NO.	PART NO.	DESCRIPTION	KEY NO.	PART NO.	DESCRIPTION
1	194203X479	Upper Handle	30	401180X004	Axle Arm Assembly	54	88348	Washer, Flat
2	183567	Engine Zone Control Cable	31	701037X421	Knob, Selector	55	188839X004	Mounting Bracket, Debris Shield
3	750634	Screw	32	401621X004	Spring, Selector			
4	850733X004	Bracket, Upstop	33	151889	Mulcher Door	56	750097	Screw, Hex Washer Head #10-24 x 1/2
5	66426	Wire Tie	34	401629	Spacer			
6	189713X428	Handle Knob	35	407501X005	Bracket, Wheel Adjuster	57	51793	Hairpin Cotter
7	407794X421	Hubcap	36	154132	Bracket, Housing	58	151590X479	Lower Handle
8	194199X421	Control Bar	38	176509	Deflector, Discharge	59	191574	Handle Bolt
9	153282X479	Support Bracket, Handle, LH	39	193248X479	Support Bracket, LH	60	74760612	Bolt
10	170345X479	Handle Bracket, RH	40	193247X479	Support Bracket, RH	61	751592	Locknut, Hex
11	153350X479	Support Bracket, Handle, RH	41	150406	Screw, Hex Head, Threaded, Rolled 3/8-16 x 1-1/8	62	405843	Debris Shield
12	170346X479	Handle Bracket, LH				63	192325	Screw
14	149741	Screw, Thread Cutting 5/16-18 x 3/4	42	152124	Spring, Torsion	64	- - -	Engine, Briggs & Stratton, Model Number 124T02 (For engine service and replacement parts, call Briggs & Stratton at 1-800-233-3723)
16	54583	Screw	43	73800400	Locknut, Hex			
17	165175X479	Support Rod	44	412210	Kit, Lawn Mower Housing (Includes Key Number 46)			
18	132004	Locknut, Keps	45	147286	Rod, Hinge			
19	194788	Rope Guide	46	189179	Blade Adapter / Pulley			
20	413160	Rear Skirt	47	406713	Blade, 22"	67	197480	O-Ring
24	192301X004	Clamp, Rear Skirt	48	851074	Washer, Hardened	72	197991	Clip, Cable
25	409149	Locknut, Hex 3/18-16	49	850263	Washer, Lock, Helical	- -	404764	Warning Decal (not shown)
27	408852X421	Wheel & Tire Assembly	50	851084	Screw, Hex Head, Grade 8 3/8-24 x 1-3/8	- -	193733	Operator's Manual, English
28	142748	Shoulder Bolt				- -	193736	Operator's Manual, French
29	401630	Washer, Curved, Cylindrical	52	404763	Decal, Danger	- -	419899	Repair Parts Manual

NOTE: All component dimensions given in U.S. inches. 1 inch = 25.4 mm. **IMPORTANT:** Use only Original Equipment Manufacturer (O.E.M.) replacement parts. Failure to do so could be hazardous, damage your lawn mower and void your warranty.

ROTARY LAWN MOWER - - MODEL NUMBER PR600Y22SHP (MFG. ID. NUMBER 96122001404)

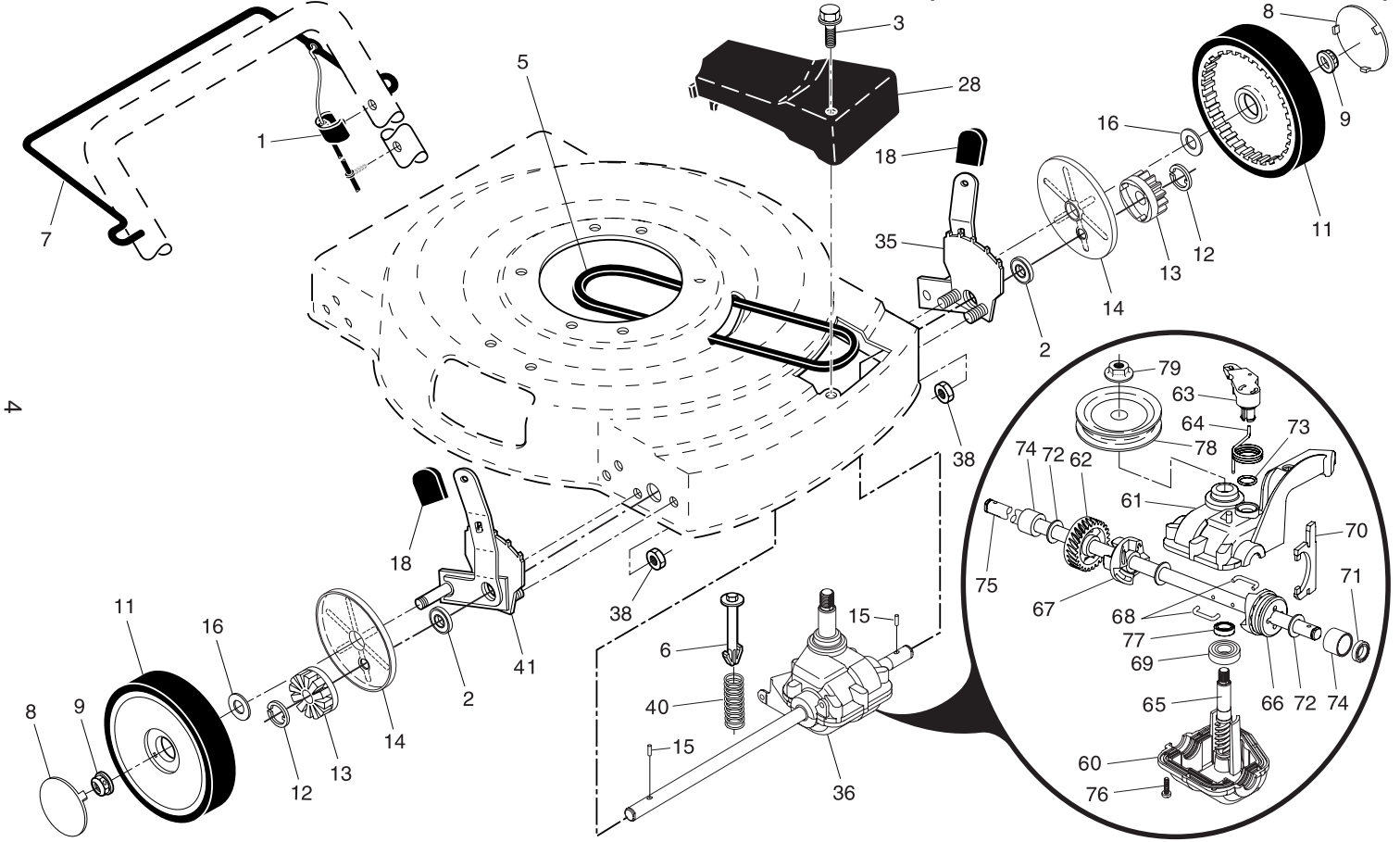

ROTARY LAWN MOWER - - MODEL NUMBER PR600Y22SHP (MFG. ID. NUMBER 96122001404)

KEY NO.	PART NO.	DESCRIPTION
1	194653	Drive Control Cable Assembly
2	191039	Bearing, Wheel Adjuster
3	143603	Pan Head Tapping Screw #10-24 x 2-3/4
5	146527	V-Belt
6	150495	Spring Retainer
7	194185X421	Control Bar, Drive
8	407793X421	Hubcap
9	409149	Locknut, Hex
11	180775	Wheel & Tire Assembly
12	12000058	E-Ring
13	403849	Pinion
14	189403	Dust Cover
15	404845	Pawl, Drive
16	67725	Washer
18	701037X421	Selector Knob
28	194398X428	Drive Cover
35	408862	Kit, Wheel Adjuster, LH (Includes Knob and Bearing)
36	415226	* Gear Case Assembly, Complete
38	73800400	Locknut, Hex 1/4-20
40	137090	Spring
41	408861	Kit, Wheel Adjuster, RH (Includes Knob and Bearing)

KEY NO.	PART NO.	DESCRIPTION
60	183497	Case, Lower
61	183498	Case, Upper
62	183499	Gear, 27 Teeth
63	183500	Lever, Clutch
64	183501	Spring, Return
65	416988	Shaft, Input
66	183503	Dog, Movable
67	183504	Dog, Fixed
68	183505	Wire, Formed
69	183506	Bearing, Ball
70	183507	Fork, Shift
71	183508	Seal, Output Shaft
72	183509	Washer
73	183510	Seal, Case
74	183511	Bushing
75	196561	Shaft, Output
76	183513	Screw
77	183514	Seal, Input Shaft
78	416987	Pulley, Drive
79	416986	Locknut, Hex

* **NOTE:** We advise Total Multis EP00 semi-liquid grease or a comparable grade (quantity 1.15 oz)

NOTE: All component dimensions given in U.S. inches. 1 inch = 25.4 mm. **IMPORTANT:** Use only Original Equipment Manufacturer (O.E.M.) replacement parts. Failure to do so could be hazardous, damage your lawn mower and void your warranty.