

LIMITED WARRANTY

The Manufacturer warrants to the original consumer purchaser that this product as manufactured is free from defects in materials and workmanship. For a period of two (2) years from date of purchase by the original consumer purchaser, we will repair or replace, at our option, without charge for parts or labor incurred in replacing parts, any part which we find to be defective due to materials or workmanship. This Warranty is subject to the following limitations and exclusions.

1. This warranty does not apply to the engine, transaxle/transmission components, battery (except as noted below) or components parts thereof. Please refer to the applicable manufacturer's warranty on these items.
2. Transportation charges for the movement of any power equipment unit or attachment are the responsibility of the purchaser. Transportation charges for any parts submitted for replacement under this warranty must be paid by the purchaser unless such return is requested by the manufacturer.
3. Battery Warranty: On products equipped with a Battery, we will replace, without charge to you, any battery which we find to be defective in manufacture, during the first ninety (90) days of ownership. After ninety (90) days, we will exchange the Battery, charging you 1/12 of the price of a new Battery for each full month from the date of the original sale. Battery must be maintained in accordance with the instructions furnished.
4. The Warranty period for any products used for rental or commercial purposes is limited to 45 days from the date of original purchase.
5. This Warranty applies only to products which have been properly assembled, adjusted, operated, and maintained in accordance with the instructions furnished. This Warranty does not apply to any product which has been subjected to alteration, misuse, abuse, improper assembly or installation, delivery damage, or to normal wear of the product.
6. Exclusions: Excluded from this Warranty are belts, blades, blade adapters, normal wear, normal adjustments, standard hardware and normal maintenance.
7. In the event you have a claim under this Warranty, you must return the product to an authorized service dealer.

Should you have any unanswered questions concerning this Warranty, contact:

Poulan
Customer Service Department
1030 Stevens Creek Road
Augusta, GA 30907 USA

In Canada contact:
Poulan
Customer Service Department
5855 Terry Fox Way
Mississauga, Ontario L5V 3E4

giving the model number, serial number and date of purchase of your product and the name and address of the authorized dealer from whom it was purchased.

THIS WARRANTY DOES NOT APPLY TO INCIDENTAL OR CONSEQUENTIAL DAMAGES AND ANY IMPLIED WARRANTIES ARE LIMITED TO THE SAME TIME PERIODS STATED HEREIN FOR OUR EXPRESSED WARRANTIES.

Some areas do not allow the limitation of consequential damages or limitations of how long an implied Warranty may last, so the above limitations or exclusions may not apply to you. This Warranty gives you specific legal rights, and you may have other rights which vary from locale to locale.

This is a limited Warranty within the meaning of that term as defined in the Magnuson-Moss Act of 1975.

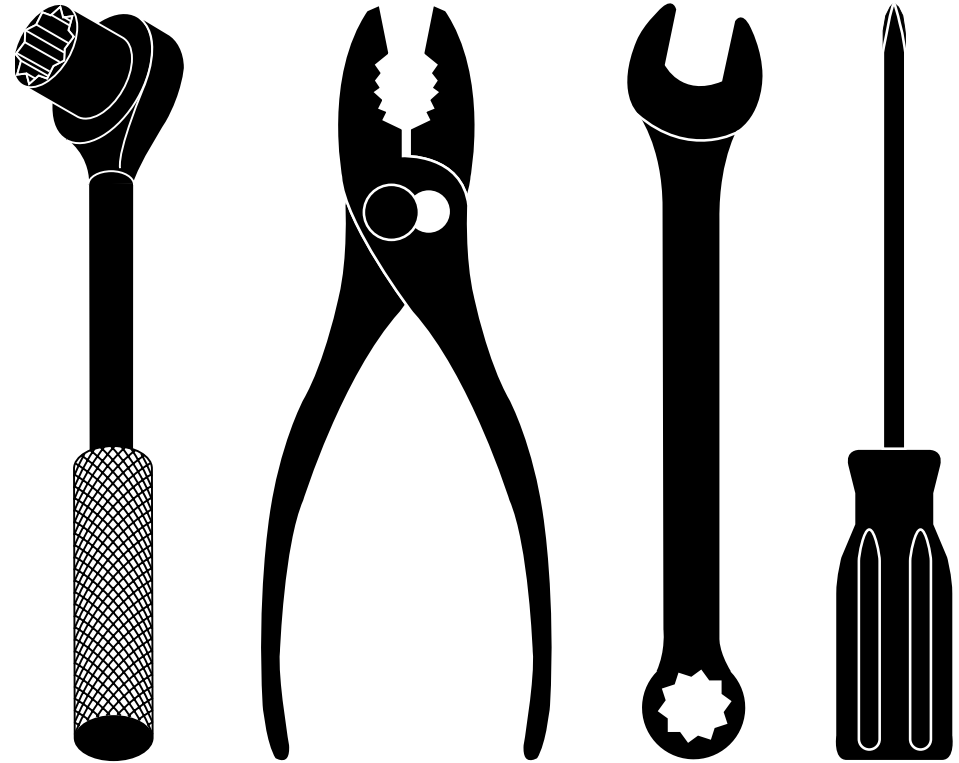

REPAIR PARTS MANUAL MODEL NO. **PO500N22S** MFG. ID. NO. **96112004103** Rotary Lawn Mower

For Parts and Service, contact our authorized distributor: call 1-800-849-1297
For Technical Assistance: call 1-800-829-5886

Poulan

Poulan

ROTARY LAWN MOWER - MODEL NUMBER PO500N22S (MFG. ID. NUMBER 96112004103)

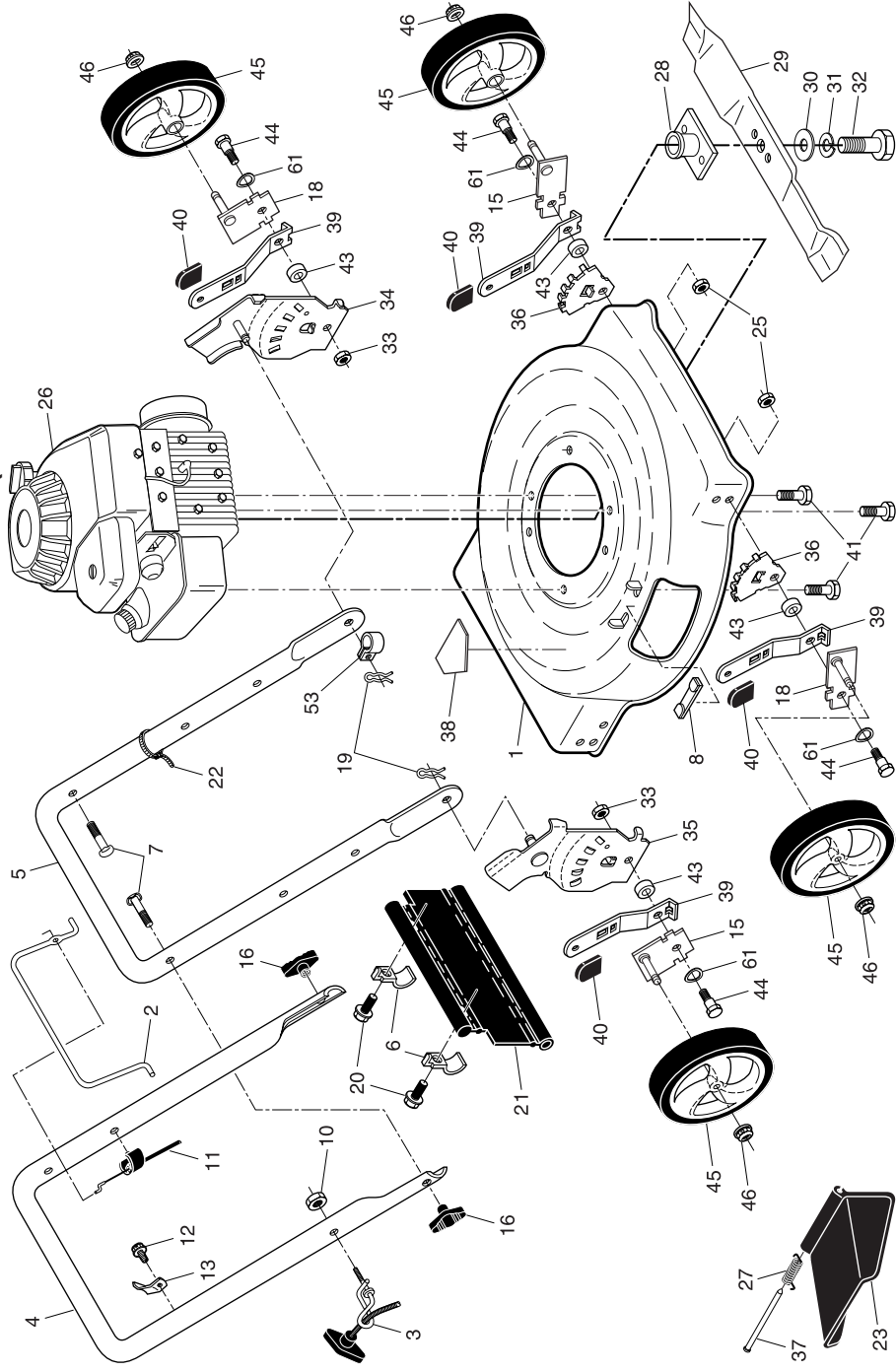

2

ROTARY LAWN MOWER - MODEL NUMBER PO500N22S (MFG. ID. NUMBER 96112004103)

KEY NO.	PART NO.	DESCRIPTION	KEY NO.	PART NO.	DESCRIPTION
1	403018	Kit, Housing (Includes Key Number 38)	27	408585	Torsion Spring
2	194177X428	Control Bar	28	851514	Blade Adapter
3	194788	Rope Guide	29	406713	22" Blade
4	194179X479	Upper Handle	30	851074	Hardened Washer
5	169708X479	Lower Handle	31	850263	Helical Lockwasher 3/8
6	192301X004	Bracket, Rear Skirt	32	851084	Screw, Hex Head, Grade 8, 3/8-24 x 1-3/8
7	191574	Handle Bolt 5/16-18	33	73930500	Nut, Hex, Flangelock 5/16-18
8	161622	Clip, Closeout	34	400781X479	Wheel Bracket Support (Left)
10	132004	Locknut, Hex 1/4-20	35	400782X479	Wheel Bracket Support (Right)
11	183281	Engine Zone Control Cable	36	407494X005	Wheel Bracket Adjuster
12	750634	Screw, Hex Head, Threaded, Rolled #10-24 x 1/2	37	160833	Hinge Rod
13	86899X004	Up-Stop Bracket	38	404763	Danger Decal
15	401174X004	Axle Arm Assembly, Left Front & Right Rear	39	401621X004	Selector Spring
16	189713X428	Handle Knob	40	87877	Selector Knob
18	401175X004	Axle Arm Assembly, Right Front & Left Rear	41	150406	Screw, Hex Head, Threaded, Rolled 3/8-16 x 1
19	51793	Hairpin Cotter	43	401629	Spacer
20	750097	Screw, Tapping, Hex Washer Head #10-24	44	401638	Shoulder Bolt 5/16-18 x .33
21	413160	Rear Skirt	45	193850X427	Wheel & Tire Assembly
22	66426	Wire Tie	46	409148	Nut, Hex, Flangelock 3/8-16
23	160831	Discharge Guard	53	197991	Clip, Cable
25	166785	Nut, Hex, Flangelock 5/16-18	61	401630	Washer, Curved, Cylindrical
26	- - -	Engine, Briggs & Stratton, Model Number 10T502-3764-B1 (For engine service and replacement parts, call Briggs & Stratton at 1-800-233-3723)	- -	404764	Warning Decal (not shown)
			- -	193732	Operator's Manual, English
			- -	193734	Operator's Manual, French
			- -	425059	Repair Parts Manual

3

IMPORTANT: Use only Original Equipment Manufacturer (O.E.M.) replacement parts. Failure to do so could be hazardous, damage your lawn mower and void your warranty.

NOTE: All component dimensions given in U.S. inches. 1 inch = 25.4 mm.