

Poulan PRO®

ENGLISH



Please do not return unit to retailer.
Por favor, no devuelva el aparato al lugar de compra.
Veuillez ne pas retourner l'outil au détaillant.

1-800-554-6723

www.poulan-pro.com

Instruction Manual Manual de Instrucciones Manuel d'Instructions

SM210VS

ESPAÑOL

IMPORTANT MANUAL - Do not throw away
MANUAL IMPORTANTE - No lo descarte
MANUEL IMPORTANT - À Conserver



WARNING:

Read and follow all Safety Rules and Operating Instructions before using this product. Failure to do so can result in serious injury.

ADVERTENCIA:

Lea el manual de instrucciones y siga todas las advertencias e instrucciones de seguridad. El no hacerlo puede resultar en lesiones graves.

AVERTISSEMENT:

Veillez lire le manuel d'instructions et bien respecter tous les avertissements et toutes les instructions de sécurité. Tout défaut de le faire pourrait entraîner des blessures graves.

Poulan PRO
1030 Stevens Creek Road
Augusta, GA 30907

Poulan PRO
850 Matheson Blvd. West
Mississauga, Ontario L5V 0B4

FRANÇAIS

545186830 Rev. 3 3/11/09 BRW

IDENTIFICATION OF SAFETY SYMBOLS



WARNING: This unit can be dangerous! Careless or improper use can cause serious injury.



Read your operator's manual carefully until you completely understand and can follow all warnings and safety rules before operating the unit. Failure to do so can result in serious injury. Save operator's manual.



The blower can throw objects violently. You can be blinded or injured. Always wear hearing protection and safety glasses marked Z87. Always wear heavy, long pants, long sleeves, boots and gloves.

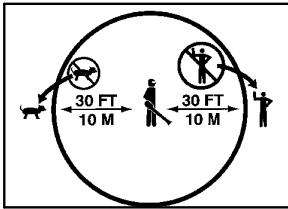

Hazard zone for thrown objects. Keep children, bystanders, and animals away from work area a minimum of 30 feet (10 meters) when starting or operating unit. Do not point blower nozzle in the direction of people or pets.



Secure hair above shoulder length. Do not wear jewelry, loose clothing, or clothing with loosing hanging straps, ties, tassels, etc. They can be caught in moving parts.

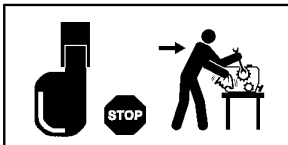

Always stop unit and disconnect spark plug before cleaning or servicing.



WARNING: Stop the engine before opening the vacuum inlet door. The engine must be stopped and the impeller blades no longer turning to avoid serious injury from the rotating blades. Gently tilt the handle of the screwdriver toward the front of the unit to release the latch while pulling up on the vacuum inlet cover with your other hand.

IDENTIFICATION OF SAFETY SYMBOLS



When using the vacuum attachment, the unit is designed to pick up dry material such as leaves, grass, small twigs, and bits of paper. Do not vacuum stones, gravel, metal, broken glass, etc., to avoid severe damage to the impeller.



⚠ WARNING: Fire hazard. Never mix, pour, or store gasoline or use the unit near a flame or sparks (including smoking, open flames, or work that can cause sparks).



⚠ WARNING: The muffler is very hot during and after use. Do not touch the muffler, muffler guard, or surrounding surfaces, or allow combustible material such as dry grass or fuel to do so.

SAFETY RULES

⚠ WARNING: Failure to follow all Safety Rules and Precautions can result in serious injury.

KNOW YOUR UNIT

- Read your instruction manual carefully until you completely understand and can follow all warnings and safety rules before operating the unit.
- Restrict unit to users who understand and will follow all warnings and safety rules in this manual.

⚠ WARNING: Inspect area before starting unit. Remove all debris and hard objects such as rocks, glass, wire, etc. that can ricochet, be thrown, or otherwise cause injury or damage during operation.

Use your unit as a blower for:

- Sweeping debris or grass clippings from driveways, sidewalks, patios, etc.
- Blowing grass clippings, straw, or leaves into piles, around joints, or between bricks.

Use your unit as a vacuum for:

- Picking up dry material such as leaves, grass, small twigs, and bits of paper.
- For best results during vacuum use, operate your unit at high speed.
- Move slowly back and forth over the material as you vacuum. Avoid forcing the unit into a pile of debris as this can clog the unit.
- Keep the vacuum tube about an inch above the ground for best results.

PLAN AHEAD

- Always wear eye protection when operating, servicing, or performing maintenance on unit. Wearing eye protection will help to prevent rocks or debris from being blown or ricocheting into eyes and face which can

result in blindness and/or serious injury. Eye protection should be marked Z87.

- Always wear foot protection. Do not go barefoot or wear sandals.
- Always wear respirator or face mask when working with unit in dusty environments.
- Secure hair so it is above shoulder length. Keep loose hair, loose clothing, fingers, and all other parts of the body away from openings and moving parts. Hair, jewelry, loose clothing, or clothing with loosely hanging straps, ties, tassels, etc., can be caught in moving parts.
- Do not operate unit when you are tired, ill, upset, or if you are under the influence of alcohol, drugs, or medication.
- Keep children, bystanders, and animals away from work area a minimum of 30 feet (10 meters) when starting or operating unit. Do not point the blower nozzle in the direction of people or pets.

HANDLE FUEL WITH CAUTION, IT IS HIGHLY FLAMMABLE

- Eliminate all sources of sparks or flame (including smoking, open flames, or work that can cause sparks) in the areas where fuel is mixed, poured, or stored.
- Mix and pour fuel in an outdoor area; store fuel in a cool, dry, well ventilated place; use an approved, marked container for all fuel purposes.
- Do not smoke while handling fuel or while operating the unit.
- Make sure the unit is properly assembled and in good operating condition.
- Do not fill fuel tank while engine is hot or running.
- Avoid spilling fuel or oil. Wipe up fuel spills before starting engine.

- Move at least 10 feet (3 meters) away from fuel and fueling site before starting engine.
- Always store gasoline in a container approved for flammable liquids.

OPERATE YOUR UNIT SAFELY

⚠ WARNING: Stop the engine before opening the vacuum inlet door. The engine must be stopped and the impeller blades no longer turning to avoid serious injury from the rotating blades.

- Inspect unit before each use for worn, loose, missing, or damaged parts. Do not use until unit is in proper working order.
- Keep outside surfaces free of oil and fuel.
- Never start or run engine inside a closed room, building or other unventilated area. Breathing exhaust fumes can kill.
- To avoid static electricity discharge, do not wear rubber gloves or any other insulated gloves while operating unit.
- Do not set unit on any surface except a clean, hard area while engine is running. Debris such as gravel, sand, dust, grass, etc. could be picked up by the air intake and thrown out through discharge opening, damaging unit, property, or causing serious injury to bystanders or operator.
- Avoid dangerous environments. Do not use in unventilated areas or where explosive vapors or carbon monoxide build up could be present.
- Do not overreach or use from unstable surfaces such as ladders, trees, steep slopes, rooftops, etc. Keep firm footing and balance at all times.
- Never place objects inside the blower tubes; always direct the blowing debris away from people, animals, glass, and solid objects such as trees, automobiles, walls, etc. The force of air can cause rocks, dirt, or sticks to be thrown or to ricochet which can hurt people or animals, break glass, or cause other damage.
- Never run unit without the proper equipment attached. When using your unit as a blower, always install blower tubes. When using your unit as a vacuum, always install vacuum tubes and vacuum bag assembly. Make sure vacuum bag assembly is completely zipped.
- Check air intake opening, blower tubes, vacuum tubes, and elbow tube frequently, always with engine stopped and spark plug disconnected. Keep vents and discharge tubes free of debris which can accumulate and restrict proper air flow.
- Never place any object in the air intake opening as this could restrict proper air flow and cause damage to the unit.
- Never use for spreading chemicals, fertilizers, or other substances which may contain toxic materials.
- To avoid spreading fire, do not use near leaf or brush fires, fireplaces, barbecue pits, ashtrays, etc.
- Use only for jobs explained in this manual.

MAINTAIN YOUR UNIT PROPERLY

⚠ WARNING: Disconnect spark plug before performing maintenance except for carburetor adjustments.

- Have all maintenance other than the recommended procedures described in the instruction manual performed by an authorized service dealer.
- Use only recommended Poulan PRO replacement parts; use of any other parts may void your warranty and cause damage to your unit.
- Empty fuel tank before storing the unit. Use up fuel left in carburetor by starting engine and letting it run until it stops.
- Do not use any accessory or attachment other than those recommended by manufacturer for use with your unit.
- Do not store the unit or fuel in a closed area where fuel vapors can reach sparks or an open flame from hot water heaters, electric motors or switches, furnaces, etc.
- Store in a dry area out of reach of children.

⚠ WARNING: The engine exhaust from this product contains chemicals known to the State of California to cause cancer, birth defects or other reproductive harm.

SPECIAL NOTICE: Exposure to vibrations through prolonged use of gasoline powered hand tools could cause blood vessel or nerve damage in the fingers, hands, and joints of people prone to circulation disorders or abnormal swelling. Prolonged use in cold weather has been linked to blood vessel damage in otherwise healthy people. If symptoms occur such as numbness, pain, loss of strength, change in skin color or texture, or loss of feeling in the fingers, hands, or joints, discontinue the use of this tool and seek medical attention. An antivibration system does not guarantee the avoidance of these problems. Users who operate power tools on a continual and regular basis must monitor closely their physical condition and the condition of this tool.

SPECIAL NOTICE: This unit is equipped with a temperature limiting muffler and spark arresting screen which meets the requirements of California Codes 4442 and 4443. All U.S. forest land and the states of California, Idaho, Maine, Minnesota, New Jersey, Oregon, and Washington require by law that many internal combustion engines be equipped with a spark arresting screen. If you operate in a locale where such regulations exist, you are legally responsible for maintaining the operating condition of these parts. Failure to do so is a violation of the law. Refer to the MAINTENANCE section for information on maintenance of the muffler and spark arresting screen.

ASSEMBLY

⚠ WARNING: Stop engine and be sure the impeller blades have stopped turning before opening the vacuum inlet door or attempting to insert or remove the vacuum or blower tubes. The rotating blades can cause serious injury. Always disconnect the spark plug before performing maintenance or accessing movable parts.

⚠ WARNING: If you receive your unit assembled, check each step to insure your unit is properly assembled and all fasteners are secure. Follow all safety information in the manual and on the unit.

- A standard screwdriver is required for assembly.

BLOWER TUBE ASSEMBLY

1. Align the rib on the upper blower tube with the groove in the blower outlet; slide the tube into place.

NOTE: Knob must be loose enough to allow blower tube to be inserted in blower outlet. Loosen knob by turning counterclockwise.

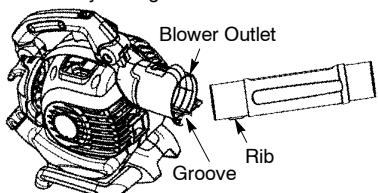

2. Secure the tube by turning the knob clockwise.
3. Align the slots on the lower blower tube with the tabs on the upper blower tube.

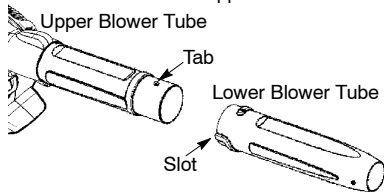

4. Slide the lower blower tube onto the upper blower tube.
5. Turn the lower blower tube clockwise until a click is felt to secure the lower blower tube to the upper blower tube.

NOTE: When the upper and lower blower tubes are assembled together properly, the arrows on both tubes will be aligned.

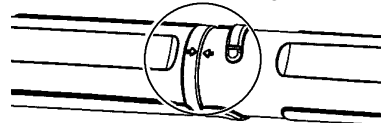

6. To remove the tubes, turn the knob counterclockwise to loosen the tubes; remove the tubes.

HIGH-SPEED NOZZLE ASSEMBLY

When greater air speed is desired, use the high-speed nozzle.

1. Align the slots on the nozzle with the tabs on the lower blower tube.

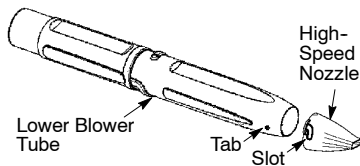

2. Slide the nozzle onto the lower blower tube.
3. Turn the nozzle clockwise until a click is felt to secure the nozzle to the lower blower tube.

VACUUM BAG ASSEMBLY

1. Open the zipper on the vacuum bag and insert the elbow tube.
2. Push the small end of the elbow tube through the small opening in the bag.

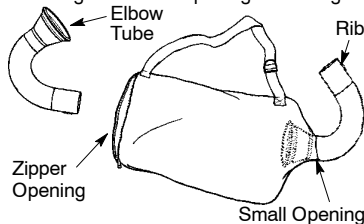

NOTE: Make sure edge of the small opening is flush against the flared area of the elbow tube, and the rib on the elbow tube is on the bottom.

3. Close the zipper on the bag. Make sure the zipper is closed completely.
4. Remove blower tubes from engine.

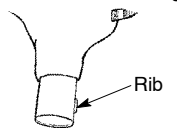

5. Insert the elbow tube into the blower outlet. Make sure elbow tube rib is aligned with the blower outlet groove.
6. Turn knob clockwise to secure elbow tube.

VACUUM TUBE ASSEMBLY

⚠ WARNING: Stop engine and be sure the impeller blades have stopped turning before opening the vacuum inlet door or attempting to insert or remove the vacuum or blower tubes. The rotating blades can cause serious injury.

1. Insert the tip of a screwdriver into the latch area of the vacuum inlet.

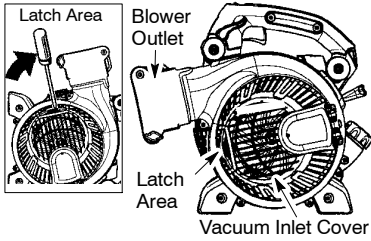

2. Gently tilt the handle of the screwdriver toward the front of the unit to release the latch while pulling up on the vacuum inlet cover with your other hand.
3. Hold the vacuum inlet cover open until upper vacuum tube is installed.

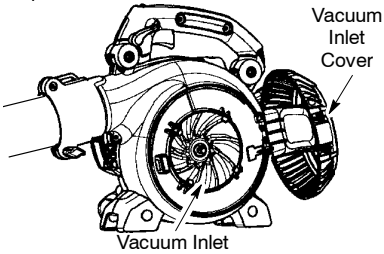

4. Align the tabs on the inside of the vacuum inlet with the slots on the upper vacuum tube.

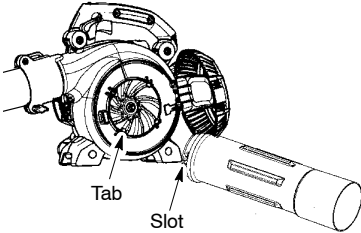

5. Push the upper vacuum tube into the vacuum inlet. Turn the tube counterclockwise until a click is felt to secure the tube to the blower unit.

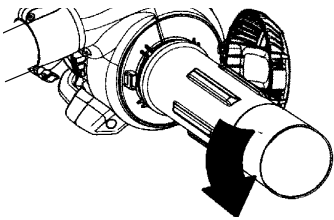

6. Align slanted end of lower vacuum tube as shown. Firmly push lower vacuum tube into upper vacuum tube.

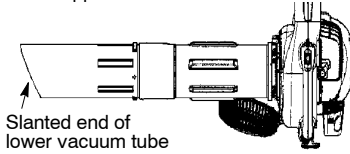

HOW TO CONVERT UNIT FROM VACUUM USE TO BLOWER USE

1. Remove the elbow tube and vacuum bag by turning the knob counterclockwise to loosen the elbow tube.
2. Remove the vacuum tubes by turning the tubes clockwise.
3. Close the vacuum inlet cover and make sure it is latched closed.
4. Reinstall the blower tubes (see BLOWER TUBE ASSEMBLY).

SHOULDER STRAP ADJUSTMENT

1. Hold the unit as shown with the muffler side facing away from your body and clothes.
2. Pass the shoulder strap over your head and onto your right shoulder.
3. Extend your left arm toward the rear of the vacuum bag.
4. Adjust shoulder strap until the vacuum bag/shoulder strap seam lies between your thumb and index finger.
5. Make sure air flows freely from the elbow tube into bag. If bag is kinked, the unit will not operate properly.

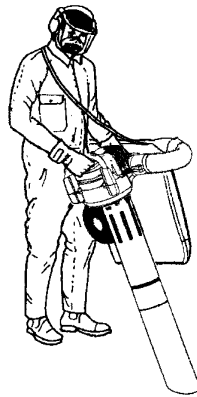

OPERATION

KNOW YOUR BLOWER

READ THIS INSTRUCTION MANUAL AND SAFETY RULES BEFORE OPERATING YOUR UNIT. Compare the illustrations with your unit to familiarize yourself with the location of the various controls and adjustments. Save this manual for future reference.

MULCHING BLADES

Your blower is equipped with mulching blades as a standard feature. When using the vacuum attachment, the mulching blades automatically reduce debris at a ratio of up to 16:1.

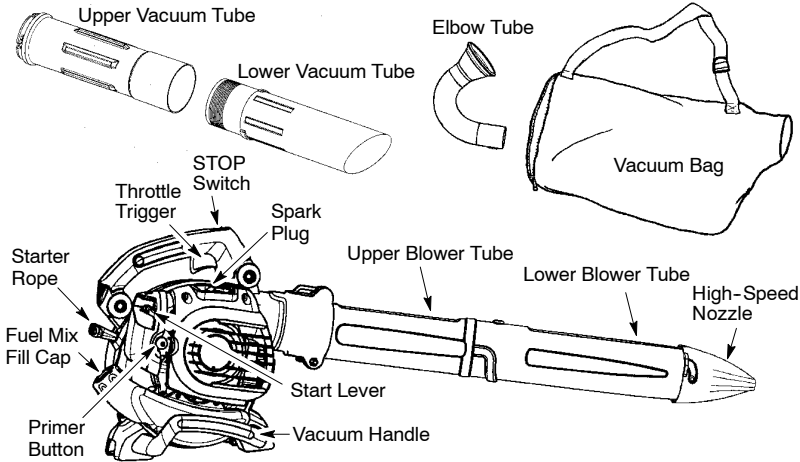

STOP SWITCH

The STOP switch is used to stop the engine. To stop the engine, push and hold the STOP switch in the STOP position until the engine stops.

THROTTLE TRIGGER

The THROTTLE TRIGGER is used to select the desired engine speed.

PRIMER BUTTON

The PRIMER BUTTON removes air from the carburetor and fuel lines and fills them with fuel. This allows you to start the engine with fewer

pulls on the starter rope. Activate primer button by pressing it and allowing it to return to its original position.

START LEVER

The START LEVER helps to supply fuel to the engine to aid in starting. Activate the starting system by moving the start lever to the START position. DO NOT squeeze the throttle trigger until the engine has started and runs. After the engine starts, allow the engine to warm-up 10-15 seconds, then fully squeeze the throttle trigger to deactivate the starting system.

OPERATING POSITION

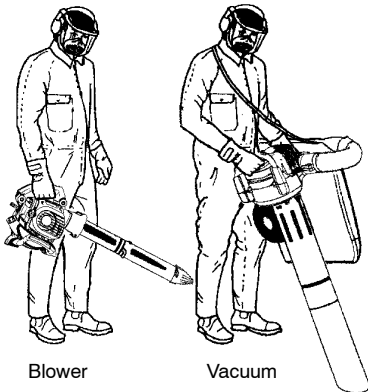

Blower

Vacuum

OPERATING TIPS

- While vacuuming or blowing debris, hold the unit with the muffler side facing away from your body and clothes (see OPERATING POSITION illustration above).
- To reduce the risk of hearing loss associated with sound level(s), hearing protection is required.
- To reduce the risk of injury associated with contacting rotating parts, stop the engine before installing or removing attachments. Do not operate without guard(s) in place.
- Operate power equipment only at reasonable hours—not early in the morning or late at night when people might be disturbed. Comply with times listed in local ordinances. Usual recommendations are 9:00 a.m. to 5:00 p.m., Monday through Saturday.
- To reduce noise levels, limit the number of pieces of equipment used at any one time.

- To reduce noise levels, operate power blowers at the lowest possible throttle speed to do the job.
- Use rakes and brooms to loosen debris before blowing.
- In dusty conditions, slightly dampen surfaces or use a mister attachment when water is available.
- Conserve water by using power blowers instead of hoses for many lawn and garden applications, including areas such as gutters, screens, patios, grills, porches, and gardens.
- Watch out for children, pets, open windows, or freshly washed cars. Blow debris away safely.
- Use the full blower nozzle extension so the air stream can work close to the ground.
- After using blowers and other equipment, CLEAN UP! Dispose of debris in trash receptacles.

BEFORE STARTING ENGINE

WARNING: Be sure to read the fuel information in the safety rules before you begin. If you do not understand the safety rules, do not attempt to fuel your unit. Call 1-800-554-6723.

FUELING ENGINE

WARNING: Remove fuel cap slowly when refueling.



HELPFUL TIP

To obtain the correct oil mix ratio, pour 3.2 ounces of 2-cycle synthetic oil into one gallon of fresh gas.

This engine is certified to operate on unleaded gasoline. Before operation, gasoline must be mixed with a good quality synthetic 2-cycle air-cooled engine oil designed to be mixed at a ratio of 40:1. Poulan PRO brand synthetic oil is recommended. Mix gasoline and oil at a ratio of 40:1. A 40:1 ratio is obtained by mixing 3.2 fluid ounces (95 ml) of oil with 1 gallon (4 liters) of unleaded gasoline. DO NOT USE automotive oil or marine oil. These oils will cause engine damage. When mixing fuel, follow instructions printed on container. Once oil is added to gasoline, shake container momentarily to assure that the fuel is thoroughly mixed. Always read and follow the safety rules relating to fuel before fueling your unit.

CAUTION: Never use straight gasoline in your unit. This will cause permanent engine damage and void the limited warranty.

FUEL REQUIREMENTS

This engine requires the use of minimum 87 octane [R+M]/2 clean gasoline.

IMPORTANT

Use of alcohol blended fuels (called gasohol or using ethanol or methanol) can cause major engine performance and durability problems.

WARNING: Alternative fuels (not gasoline) such as E-15 (15% alcohol), E-20 (20% alcohol), E-85 (85% alcohol) are NOT classified as gasoline and are NOT approved for use in 2-stroke gasoline engines. Use of alternative fuels will cause problems such as: improper clutch engagements, overheating, vapor lock, power loss, lubrication deficiency, deterioration of fuel lines, gaskets and internal carburetor components, etc. Alternative fuels cause high moisture absorption into the fuel/oil mixture leading to oil and fuel separation.

HOW TO STOP YOUR ENGINE

- Release the throttle trigger.
- Push and hold the STOP switch in the STOP position until the engine stops.

HOW TO START YOUR ENGINE

WARNING: You MUST make sure the tubes are secure before using the unit.

- Fuel engine. Move at least 10 feet (3 meters) away from the fueling site.
- Hold the unit in the starting position as shown. Make sure the blower end is directed away from people, animals, glass, and solid objects.

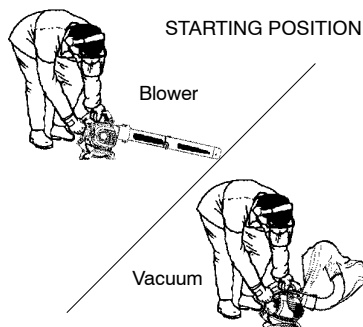

WARNING: When starting engine, hold the unit as illustrated. Do not set unit on any surface except a clean, hard area when starting engine or while engine is running. Debris such as gravel, sand, dust, grass, etc. could be picked up by the air intake and thrown out through the discharge opening, damaging the unit or property, or causing serious injury to bystanders or the operator.



HELPFUL TIP

If your engine still does not start after following these instructions, please call 1-800-554-6723.

STARTING A COLD ENGINE (or warm engine after running out of fuel)

1. Move the throttle position lever (cruise control) to the idle position.

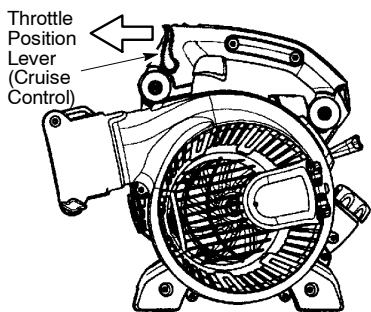

2. Slowly press the primer bulb 6 times.
3. Move the start lever to the START position.

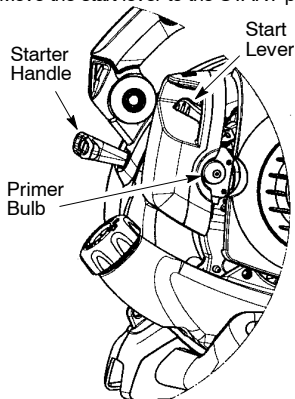

4. Pull starter rope handle sharply until engine starts and runs.
5. Allow unit to run for 10-15 seconds, then fully squeeze the throttle trigger to disengage the starting system.

STARTING A WARM ENGINE

1. Squeeze and hold the throttle trigger.
2. Pull starter rope sharply while squeezing throttle trigger until engine runs.

NOTE: Normally, the warm starting procedure can be used within 5-10 minutes after the unit is turned off. If the unit sits for more than 10 minutes without being used, it will be necessary to start the unit by following the steps under STARTING A COLD ENGINE or following the starting instruction steps shown on the unit.

STARTING A FLOODED ENGINE

Flooded engines can be started by moving the start lever to the RUN position and fully squeezing the throttle trigger. Pull the starter handle repeatedly while squeezing throttle trigger until engine starts and runs. This could require pulling the starter handle many times, depending on how badly the unit is flooded. If the unit still doesn't start, refer to the TROUBLESHOOTING TABLE or call 1-800-554-6723.

MAINTENANCE

⚠ WARNING: Avoid touching muffler unless engine and muffler are cold. A hot muffler can cause serious burns.

⚠ WARNING: Stop engine and be sure the impeller blades have stopped turning before opening the vacuum inlet door or attempting to insert or remove the vacuum or blower tubes. The rotating blades can cause serious injury. Always disconnect the spark plug before performing maintenance or accessing movable parts.

HELPFUL TIP

IMPORTANT: Have all repairs other than the recommended maintenance described in the instruction manual performed by an authorized service dealer.

If any dealer other than an authorized service dealer performs work on the product, Poulan PRO may not pay for repairs under warranty. It is your responsibility to maintain and perform general maintenance.

GENERAL RECOMMENDATIONS

The warranty on this unit does not cover items that have been subjected to operator abuse or negligence. To receive full value from the warranty, the operator must maintain unit as instructed in this manual. Various adjustments will need to be made periodically to properly maintain your unit.

CHECK FOR LOOSE FASTENERS AND PARTS

- Muffler
- Spark Plug Boot
- Air Filter
- Housing Screws

CHECK FOR DAMAGED OR WORN PARTS

Contact an authorized service dealer for replacement of damaged or worn parts.

- Fuel Tank - Do not use unit if fuel tank shows signs of damage or leaks.
- Vacuum Bag - Do not use vacuum bag if it is torn or damaged.

INSPECT AND CLEAN UNIT AND DECALS

- After each use, inspect complete unit for loose or damaged parts. Clean the unit and decals using a damp cloth with a mild detergent.

- Wipe off unit with a clean dry cloth.

CLEAN AIR FILTER

A dirty air filter decreases engine performance and increases fuel consumption and harmful emissions. Always clean or replace air filter after every 5 hours of operation or yearly, whichever comes first.

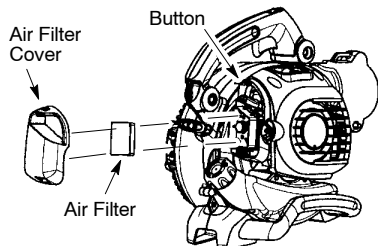

Cleaning the air filter:

1. Clean the cover and the area around it to keep debris from falling into the carburetor chamber when the cover is removed.

NOTE: Move choke lever to RUN position before opening air filter cover.

2. Open air filter cover by pushing button (see illustration). Remove air filter.

NOTE: Do not clean filter in gasoline or other flammable solvent. Doing so can create a fire hazard or produce harmful evaporative emissions.

3. Wash the filter in soap and water.
4. Allow filter to dry.
5. Apply a few drops of oil to the filter; squeeze filter to distribute oil.
6. Replace parts.

REPLACE SPARK PLUG

Replace spark plug each year to ensure the engine starts easier and runs better. Set spark plug gap at 0.025 inch (0.6 mm). Ignition timing is fixed, nonadjustable.

1. Twist, then pull off spark plug boot.
2. Remove spark plug from cylinder and discard.
3. Replace with Champion RCJ-6Y spark plug and tighten securely with a 3/4 inch (19 mm) socket wrench.
4. Reinstall the spark plug boot.

REPLACE FUEL FILTER

To replace fuel filter, drain unit by running it dry of fuel, then remove fuel cap/retainer assembly from tank. Pull filter from tank and remove it from the fuel line. Install new fuel filter on fuel line; reinstall parts.

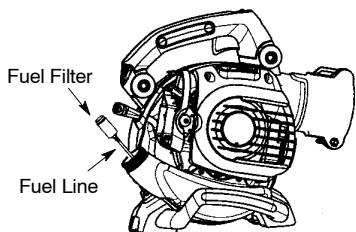

CHECK MUFFLER MOUNTING SCREWS

Once each year, ensure muffler mounting screws are tightened securely to prevent damage.

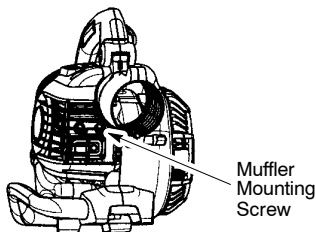

INSPECT MUFFLER AND SPARK ARRESTING SCREEN

WARNING: The muffler on this product contains chemicals known to the State of California to cause cancer.

As the unit is used, carbon deposits build up on the muffler and spark arresting screen, and must be removed to avoid creating a fire hazard or affecting engine performance.

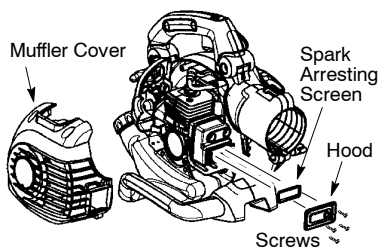

Replace the spark arresting screen every 50 hours of operation or if any damage or breaks in the screen are noted.

NOTE: Do not attempt to clean the spark arresting screen.

1. Remove 3 screws from muffler cover. Remove muffler cover.
2. Loosen and remove 4 screws from the muffler hood.
3. Remove the muffler hood and spark arresting screen.
4. Install new spark arresting screen.
5. Reinstall muffler hood and 4 screws. Tighten screws securely.
6. Reinstall muffler cover and 3 screws. Tighten securely.

NOTE: If any part of the muffler is cracked, broken or damaged, we recommend that the muffler be replaced.

CARBURETOR IDLE SPEED ADJUSTMENT

The carburetor has been carefully set at the factory. Adjustments may be necessary if you notice any of the following conditions:

- Engine will not idle when the throttle is released.

To adjust idle speed:

Allow engine to idle. Adjust speed until engine runs without stalling (idle speed too slow).

- Turn idle speed screw clockwise to increase engine speed if engine stalls or dies.
- Turn idle speed screw counterclockwise to decrease engine speed.

Idle Speed Screw

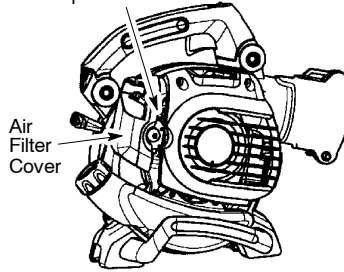

If you require further assistance or are unsure about performing this procedure, contact an authorized service dealer or call 1-800-554-6723.

STORAGE

WARNING: Perform the following steps after each use:

- Allow engine to cool, and secure the unit before storing or transporting.
- Store unit and fuel in a well ventilated area where fuel vapors cannot reach sparks or open flames from water heaters, electric motors or switches, furnaces, etc.
- Store unit with all guards in place. Position unit so that any sharp object cannot accidentally cause injury.
- Store unit and fuel well out of the reach of children.

SEASONAL STORAGE

Prepare unit for storage at end of season or if it will not be used for 30 days or more.

If your unit is to be stored for a period of time:

- Clean the entire unit before lengthy storage.
- Store in a clean dry area.
- Lightly oil external metal surfaces.

FUEL SYSTEM

Under FUELING ENGINE in the OPERATION section of this manual, see message labeled IMPORTANT regarding the use of gasoline in your engine.

Fuel stabilizer is an acceptable alternative in minimizing the formation of fuel gum deposits during storage. Add stabilizer to gasoline in fuel tank or fuel storage container. Follow the mix instructions found on stabilizer container. Run engine at least 5 minutes after adding stabilizer.

HELPFUL TIP

During storage of your gas/oil mixture, the oil will separate from the gas.

We recommend that you shake the gas can weekly to insure proper blending of the gas and oil.



ENGINE

- Remove spark plug and pour 1 teaspoon of 40:1, 2-cycle engine oil (air cooled) through the spark plug opening. Slowly pull the starter rope 8 to 10 times to distribute oil.
- Replace spark plug with new one of recommended type and heat range.
- Clean air filter.
- Check entire unit for loose screws, nuts, and bolts. Replace any damaged, broken, or worn parts.
- At the beginning of the next season, use only fresh fuel having the proper gasoline to oil ratio.

OTHER

- Do not store gasoline from one season to another.
- Replace your gasoline can if it starts to rust.

TROUBLESHOOTING TABLE

⚠ WARNING: Always stop unit and disconnect spark plug before performing any of the recommended remedies below other than remedies that require operation of the unit.

TROUBLE	CAUSE	REMEDY
Engine will not start.	<ol style="list-style-type: none"> 1. Engine flooded. 2. Fuel tank empty. 3. Spark plug not firing. 4. Fuel not reaching carburetor. 5. Compression low. 	<ol style="list-style-type: none"> 1. See "Starting a Flooded Engine" in Operation section. 2. Fill tank with correct fuel mixture. 3. Install new spark plug. 4. Check for dirty fuel filter; replace. Check for kinked or split fuel line; repair or replace. 5. Contact an authorized service dealer.
Engine will not idle properly.	<ol style="list-style-type: none"> 1. Fuel not reaching carburetor. 2. Carburetor requires adjustment. 3. Crankshaft seals worn. 4. Compression low. 	<ol style="list-style-type: none"> 1. Check for dirty fuel filter; replace. Check for kinked or split fuel line; repair or replace. 2. See "Carburetor Idle Speed Adjustment" in Service and Adjustments Section. 3. Contact an authorized service dealer 4. Contact an authorized service dealer.
Engine will not accelerate, lacks power, or dies under a load.	<ol style="list-style-type: none"> 1. Air filter dirty. 2. Fuel not reaching carburetor. 3. Spark plug fouled. 4. Carburetor requires adjustment. 5. Carbon build up. 6. Compression low. 	<ol style="list-style-type: none"> 1. Clean or replace air filter. 2. Check for dirty fuel filter; replace. Check for kinked or split fuel line; repair or replace. 3. Clean or replace spark plug and re-gap. 4. Contact an authorized service dealer. 5. Contact an authorized service dealer. 6. Contact an authorized service dealer.
Engine smokes excessively.	<ol style="list-style-type: none"> 1. Choke partially on. 2. Fuel mixture incorrect. 3. Air filter dirty. 4. Carburetor requires adjustment. 	<ol style="list-style-type: none"> 1. Adjust choke. 2. Empty fuel tank and refill with correct fuel mixture. 3. Clean or replace air filter. 4. Contact an authorized service dealer.
Engine runs hot.	<ol style="list-style-type: none"> 1. Fuel mixture incorrect. 2. Spark plug incorrect. 3. Carburetor requires adjustment. 4. Carbon build up. 	<ol style="list-style-type: none"> 1. See "Fueling Engine" in Operation section. 2. Replace with correct spark plug. 3. Contact an authorized service dealer. 4. Contact an authorized service dealer.

LIMITED WARRANTY

Poulan PRO, a division of Husqvarna Consumer Outdoor Products N.A., Inc., warrants to the original consumer purchaser that each new **Poulan PRO** brand gasoline tool or attachment is free from defects in material and workmanship and agrees to repair or replace under this warranty any defective gasoline product or attachment as follows from the original date of purchase.

2 YEARS - Parts and Labor, when used for household purposes.

90 DAYS - Parts and Labor, when used for commercial, professional, or income producing purposes.

30 DAYS - Parts and Labor, if used for rental purposes.

This warranty is not transferable and does not cover damage or liability caused by improper handling, improper maintenance or alteration, or the use of accessories and/or attachments not specifically recommended by **Poulan PRO** for this tool. This warranty does not cover tune-up, spark plugs, filters, starter ropes, or blower and vacuum tubes that will wear and require replacement with reasonable use during the warranty period. This warranty does not cover pre-delivery setup or normal adjustments explained in the instruction manual. This warranty does not cover transportation costs.

In the event you have a claim under this warranty, you must return the product to an authorized service dealer.

Should you have any unanswered questions concerning this warranty, please contact:

Poulan PRO, a division of Husqvarna Consumer Outdoor Products N.A., Inc.
1030 Stevens Creek Road
Augusta, GA 30907
1-800-554-6723

In Canada, contact:

Poulan PRO
850 Matheson Blvd. West
Mississauga, Ontario L5V 0B4

Giving the model number, serial number and date of purchase of your product and the name and address of the authorized dealer from whom it was purchased.

THIS WARRANTY GIVES YOU SPECIFIC LEGAL RIGHTS, AND YOU MAY HAVE OTHER RIGHTS WHICH VARY FROM STATE TO STATE.

NO CLAIMS FOR CONSEQUENTIAL OR OTHER DAMAGES WILL BE ALLOWED, AND THERE ARE NO OTHER EXPRESS WARRANTIES EXCEPT THOSE EXPRESSLY STIPULATED HEREIN.

SOME STATES DO NOT ALLOW LIMITATIONS ON HOW LONG AN IMPLIED WARRANTY LASTS OR THE EXCLUSION OR LIMITATIONS OF INCIDENTAL OR CONSEQUENTIAL DAMAGES, SO THE ABOVE LIMITATIONS OR EXCLUSION MAY NOT APPLY TO YOU.

This is a limited warranty within the meaning of that term as defined in the Magnuson-Moss Act of 1975.

The policy of **Poulan PRO** is to continuously improve its products. Therefore, **Poulan PRO** reserves the right to change, modify, or discontinue models, designs, specifications, and accessories of all products at any time without notice or obligation to any purchaser.

U.S. EPA/CALIFORNIA/ENVIRONMENT CANADA EMISSION CONTROL WARRANTY STATEMENT

YOUR WARRANTY RIGHTS AND OBLIGATIONS: The U.S. Environmental Protection Agency, California Air Resources Board, Environment Canada and Poulan PRO are pleased to explain the emissions control system warranty on your year 2009 and later small off-road engine. In California, all small off-road engines must be designed, built, and equipped to meet the State's stringent anti-smog standards. Poulan PRO must warrant the emission control system on your small off-road engine for the periods of time listed below provided there has been no abuse, neglect, or improper maintenance of your small off-road engine. Your emission control system includes parts such as the carburetor, the ignition system and the fuel tank. Where a warrantable condition exists, Poulan PRO will repair your small off-road engine at no cost to you. Expenses covered under warranty include diagnosis, parts and labor.

MANUFACTURER'S WARRANTY COVERAGE: If any emissions related part on your engine (as listed under Emissions Control Warranty Parts List) is defective or a defect in the materials or workmanship of the engine causes the failure of such an emission related part, the part will be repaired or replaced by Poulan PRO. **OWNER'S WARRANTY RESPONSIBILITIES:** As the small off-road engine owner, you are responsible for the performance of the required maintenance listed in your instruction manual. Poulan PRO recommends that you retain all receipts covering maintenance on your small off-road engine, but Poulan PRO cannot deny warranty solely for the lack of receipts or for your failure to ensure the performance of all scheduled maintenance. As the small off-road engine owner, you should be aware that Poulan PRO may deny you warranty coverage if your small off-road engine or a part of it has failed due to

abuse, neglect, improper maintenance, unapproved modifications, or the use of parts not made or approved by the original equipment manufacturer. You are responsible for presenting your small off-road engine to an Poulan PRO authorized repair center as soon as a problem exists. Warranty repairs should be completed in a reasonable amount of time, not to exceed 30 days. If you have any questions regarding your warranty rights and responsibilities, you should contact your nearest authorized service center, call Poulan PRO at 1-800-554-6723, or send e-mail correspondence to emission.warranty@HCOP-emission.com. **WARRANTY COMMENCEMENT DATE:** The warranty period begins on the date the small off-road engine is purchased. **LENGTH OF COVERAGE:** This warranty shall be for a period of two years from the initial date of purchase. **WHAT IS COVERED: REPAIR OR REPLACEMENT OF PARTS.** Repair or replacement of any warranted part will be performed at no charge to the owner at an approved Poulan PRO servicing center. If you have any questions regarding your warranty rights and responsibilities, you should contact your nearest authorized service center, call Poulan PRO at 1-800-554-6723, or send e-mail correspondence to emission.warranty@HCOP-emission.com. **WARRANTY PERIOD:** Any warranted part which is not scheduled for replacement as required maintenance, or which is scheduled only for regular inspection to the effect of "repair or replace as necessary" shall be warranted for 2 years. Any warranted part which is scheduled for replacement as required maintenance shall be warranted for the period of time up to the first scheduled replacement point for that part. **DIAGNOSIS:** The owner shall not be charged for diagnostic labor which leads to the determination that a

warranted part is defective if the diagnostic work is performed at an approved Poulan PRO servicing center. **CONSEQUENTIAL DAMAGES:** Poulan PRO may be liable for damages to other engine components caused by the failure of a warranted part still under warranty. **WHAT IS NOT COVERED:** All failures caused by abuse, neglect, or improper maintenance are not covered. **ADD-ON OR MODIFIED PARTS:** The use of add-on or modified parts can be grounds for disallowing a warranty claim. Poulan PRO is not liable to cover failures of warranted parts caused by the use of add-on or modified parts. **HOW TO FILE A CLAIM:** If you have any questions regarding your warranty rights and responsibilities, you should contact your nearest authorized service center, call Poulan PRO at 1-800-554-6723, or send e-mail correspondence to emission.warranty@HCOP-emission.com. **WHERE TO GET WARRANTY SERVICE:** Warranty services or repairs shall be provided at all Poulan PRO service centers. Call: 1-800-554-6723 or send e-mail correspondence to emission.warranty@HCOP-emission.com. **MAINTENANCE, REPLACEMENT AND REPAIR OF EMISSION RELATED PARTS:** Any Poulan PRO approved replacement part used in the performance of any warranty maintenance or repair on emission related parts will be provided without charge to the owner if the part is under warranty. **EMISSION CONTROL WARRANTY PARTS LIST:** Carburetor, air filter (covered up to maintenance schedule), ignition system: spark plug (covered up to maintenance schedule), ignition module, muffler including catalyst (if equipped), fuel tank. **MAINTENANCE STATEMENT:** The owner is responsible for the performance of all required maintenance as defined in the instruction manual.

The information on the product label indicates which standard your engine is certified. Example: (Year) EPA and/or CALIFORNIA.

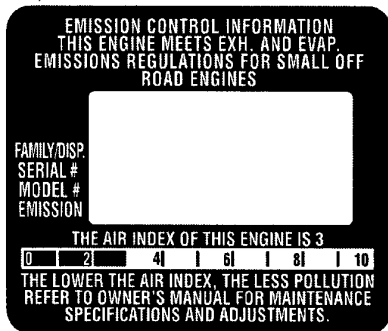

This engine is certified to be emissions compliant for the following use:

- Moderate (50 hours)
- Intermediate (125 hours)
- Extended (300 hours)