

Poulan PRO[®]

PP3440

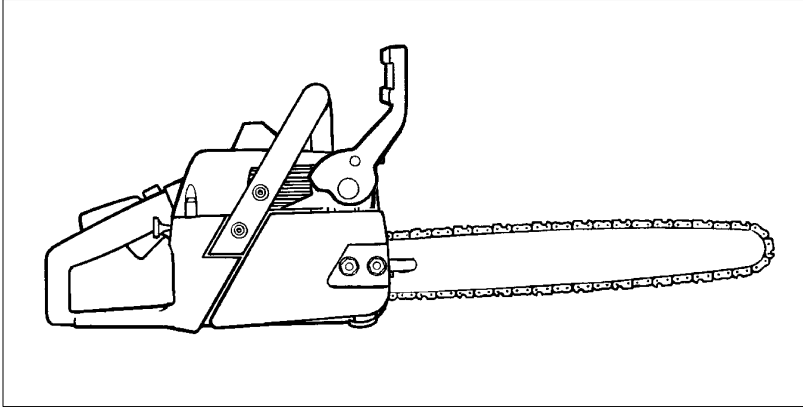

GB

INSTRUCTION MANUAL

IMPORTANT INFORMATION: Please read these instructions carefully and make sure you understand them before using this unit. Retain these instructions for future reference.

ES

MANUAL DE INSTRUCCIONES

INFORMACIÓN IMPORTANTE: Lea atentamente las instrucciones y asegúrese de entenderlas antes de utilizar esta aparato. Conserve las instrucciones para la referencia en el futuro.

FR

MANUEL D'INSTRUCTIONS

RENSEIGNEMENTS IMPORTANTS: Avant d'utiliser cet appareil, veuillez lire attentivement les instructions et assurez-vous de les avoir comprises. Conservez les instructions pour référence ultérieure.

PT

MANUAL DO OPERADOR

INFORMAÇÕES IMPORTANTES: Queira ler cuidadosamente estas instruções e tenha certeza de entendê-las antes de usar a serra e guarde para consulta futura.

RU

РУКОВОДСТВО ПО ЭКСПЛУАТАЦИИ

ВАЖНАЯ ИНФОРМАЦИЯ: Прежде чем приступить к работе с машиной внимательно прочитайте инструкцию и убедитесь, что Вам все понятно.

IDENTIFICATION (WHAT IS WHAT?)

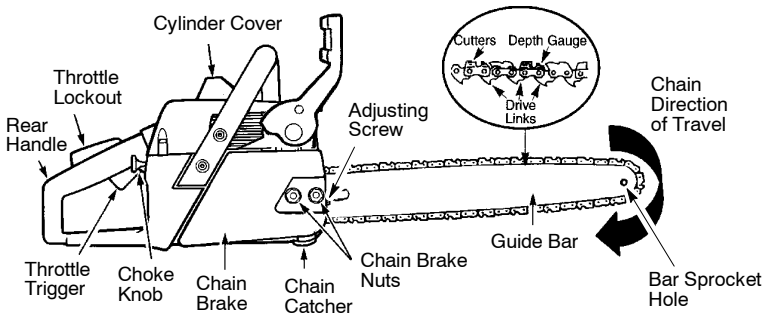
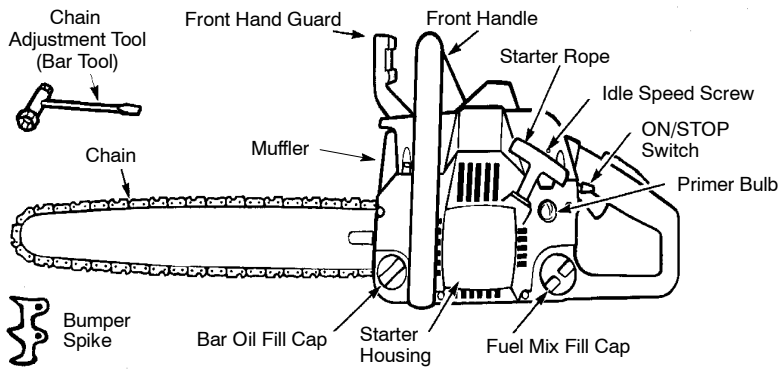

IDENTIFICATION OF SYMBOLS



WARNING! This chain saw can be dangerous! Careless or improper use can cause serious or even fatal injury.

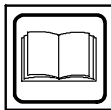

Read and understand the instruction manual before using the chain saw.



Always wear appropriate ear protection, eye protection and head protection.



Sound power level



Always use two hands when operating the chain saw.



Sound pressure level at 7,5 meters



WARNING! Contacting the guide bar tip with any object should be avoided; tip contact may cause the guide bar to move suddenly upward and backward, which may cause serious injury.

IDENTIFICATION OF SYMBOLS

Starting Reminder



Move ON/STOP switch to the ON position.



Slowly press primer bulb 6 times.



Pull choke/fast idle lever out to the full extent (to the FULL CHOKE position).

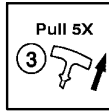

Pull the starter rope sharply 5 times with your right hand.

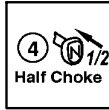

Push the choke/fast idle lever in to the HALF CHOKE position.



Pull the starter rope sharply with your right hand until the engine starts.

SAFETY RULES

WARNING: Always disconnect spark plug wire and place wire where it cannot contact spark plug to prevent accidental starting when setting up, transporting, adjusting or making repairs except carburetor adjustments. Because a chain saw is a high-speed wood-cutting tool, special safety precautions must be observed to reduce the risk of accidents. Careless or improper use of this tool can cause serious injury.

PLAN AHEAD

- Read this manual carefully until you completely understand and can follow all safety rules, precautions, and operating instructions before attempting to use the unit.
- Restrict the use of your saw to adult users who understand and can follow safety rules, precautions, and operating instructions found in this manual.

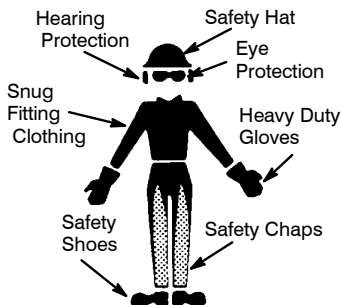

- Wear protective gear. Always use steel-toed safety footwear with non-slip soles; snug-fitting clothing; heavy-duty, non-slip gloves; eye protection such as non-fogging, vented goggles or face screen; an approved safety hard hat; and sound barriers (ear plugs or

mufflers) to protect your hearing. Regular users should have hearing checked regularly as chain saw noise can damage hearing. Secure hair above shoulder length.

- Keep all parts of your body away from the chain when the engine is running.
- Keep children, bystanders, and animals a minimum of 10 Meters away from the work area. Do not allow other people or animals to be near the chain saw when starting or operating the chain saw.
- Do not handle or operate a chain saw when you are fatigued, ill, or upset, or if you have taken alcohol, drugs, or medication. You must be in good physical condition and mentally alert. Chain saw work is strenuous. If you have any condition that might be aggravated by strenuous work, check with your doctor before operating a chain saw.
- Carefully plan your sawing operation in advance. Do not start cutting until you have a clear work area, secure footing, and, if you are felling trees, a planned retreat path.

OPERATE YOUR SAW SAFELY

- Do not operate a chain saw with one hand. Serious injury to the operator, helpers, bystanders or any combination of these persons may result from one-handed operation. A chain saw is intended for two-handed use.
- Operate the chain saw only in a well-ventilated outdoor area.
- Do not operate saw from a ladder or in a tree, unless you are specifically trained to do so.
- Make sure the chain will not make contact with any object while starting the engine. Never try to start the saw when the guide bar is in a cut.
- Do not put pressure on the saw at the end of the cut. Applying pressure can cause you to lose control when the cut is completed.
- Stop the engine before setting the saw down.
- Do not operate a chain saw that is damaged, improperly adjusted, or not completely and

securely assembled. Always replace bar, chain, hand guard, or chain brake immediately if it becomes damaged, broken or is otherwise removed.

- With the engine stopped, hand carry the chain saw with the muffler away from your body, and the guide bar and chain to the rear, preferably covered with a scabbard.

MAINTAIN YOUR SAW IN GOOD WORKING ORDER

- Have all chain saw service performed by a qualified service dealer with the exception of the items listed in the maintenance section of this manual. For example, if improper tools are used to remove or hold the flywheel when servicing the clutch, structural damage to the flywheel can occur and cause the flywheel to burst.
- Make certain the saw chain stops moving when the throttle trigger is released. For correction, refer to CARBURETOR ADJUSTMENTS.
- Never modify your saw in any way. Use only attachments supplied or specifically recommended by the manufacturer.
- Keep the handles dry, clean, and free of oil or fuel mixture.
- Keep fuel and oil caps, screws, and fasteners securely tightened.
- Use only Poulan PRO accessories and replacement parts as recommended.

HANDLE FUEL WITH CAUTION

- Do not smoke while handling fuel or while operating the saw.
- Eliminate all sources of sparks or flame in the areas where fuel is mixed or poured. There should be no smoking, open flames, or work that could cause sparks. Allow engine to cool before refueling.
- Mix and pour fuel in an outdoor area on bare ground; store fuel in a cool, dry, well ventilated place; and use an approved, marked container for all fuel purposes. Wipe up all fuel spills before starting saw.
- Move at least 10 feet (3 meters) from fueling site before starting engine.
- Turn the engine off and let saw cool in a non-combustible area, not on dry leaves, straw, paper, etc. Slowly remove fuel cap and refuel unit.
- Store the unit and fuel in an area where fuel vapors cannot reach sparks or open flames from water heaters, electric motors or switches, furnaces, etc.

KICKBACK

⚠ WARNING: Avoid kickback which can result in serious injury. **Kickback** is the backward, upward or sudden forward motion of the guide bar occurring when the saw chain near the upper tip of the guide bar contacts any object such as a log or branch, or when the wood closes in and pinches the saw chain in the cut. Contacting a foreign object in the wood can also result in loss of chain saw control.

- **Rotational Kickback** can occur when the moving chain contacts an object at the upper tip of the guide bar. This contact can cause the chain to dig into the object, which stops the chain for an instant. The result is a lightning fast, reverse reaction which kicks the guide bar up and back toward the operator.
- **Pinch-Kickback** can occur when the wood closes in and pinches the moving saw chain in the cut along the top of the guide bar and the saw chain is suddenly stopped. This sudden stopping of the chain results in a reversal of the chain force used to cut wood and causes the saw to move in the opposite direction of the chain rotation. The saw is driven straight back toward the operator.
- **Pull-In** can occur when the moving chain contacts a foreign object in the wood in the cut along the bottom of the guide bar and the saw chain is suddenly stopped. This sudden stopping pulls the saw forward and away from the operator and could easily cause the operator to lose control of the saw.

Avoid Pinch-Kickback:

- Be extremely aware of situations or obstructions that can cause material to pinch the top of or otherwise stop the chain.
- Do not cut more than one log at a time.
- Do not twist the saw as the bar is withdrawn from an undercut when bucking.

Avoid Pull-In:

- Always begin cutting with the engine at full speed and the saw housing against wood.
- Use wedges made of plastic or wood. Never use metal to hold the cut open.

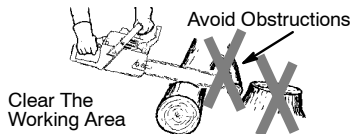
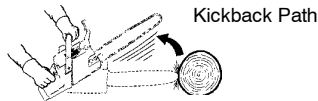

REDUCE THE CHANCE OF KICKBACK

- Recognize that kickback can happen. With a basic understanding of kickback, you can reduce the element of surprise which contributes to accidents.
- Never let the moving chain contact any object at the tip of the guide bar.
- Keep the working area free from obstructions such as other trees, branches, rocks, fences, stumps, etc. Eliminate or avoid any obstruction that your saw chain could hit while you are cutting through a particular log or branch.
- Keep your saw chain sharp and properly tensioned. A loose or dull chain can increase the chance of kickback occurring. Follow manufacturer's chain sharpening and maintenance instructions. Check tension at regu-

lar intervals with the engine stopped, never with the engine running. Make sure the bar clamp nuts are securely tightened after tensioning the chain.

- Begin and continue cutting at full speed. If the chain is moving at a slower speed, there is greater chance of kickback occurring.
- Cut one log at a time.
- Use extreme caution when re-entering a previous cut.
- Do not attempt cuts starting with the tip of the bar (plunge cuts).
- Watch for shifting logs or other forces that could close a cut and pinch or fall into chain.
- Use the Reduced-Kickback Guide Bar and Low-Kickback Chain specified for your saw.

MAINTAIN CONTROL

Stand to the left of the saw

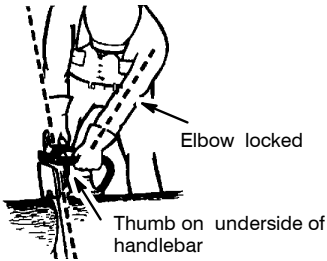
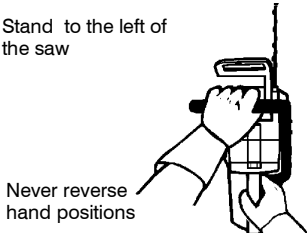

- Keep a good, firm grip on the saw with both hands when the engine is running and don't let go. A firm grip will help you reduce kickback and maintain control of the saw. Keep the fingers of your left hand encircling and your left thumb under the front handlebar. Keep your right hand completely around the rear handle whether you are right handed or left handed. Keep your left arm straight with the elbow locked.
- Position your left hand on the front handlebar so it is in a straight line with your right hand on the rear handle when making bucking cuts. Never reverse right and left hand positions for any type of cutting.
- Stand with your weight evenly balanced on both feet.
- Stand slightly to the left side of the saw to keep your body from being in a direct line with the cutting chain.
- Do not overreach. You could be drawn or thrown off balance and lose control of the saw.

- Do not cut above shoulder height. It is difficult to maintain control of saw above shoulder height.

KICKBACK SAFETY FEATURES

⚠ WARNING: The following features are included on your saw to help reduce the hazard of kickback; however, such features will not totally eliminate this dangerous reaction. As a chain saw user, do not rely only on safety devices. You must follow all safety precautions, instructions, and maintenance in this manual to help avoid kickback and other forces which can result in serious injury.

- Reduced-Kickback Guide Bar, designed with a small radius tip which reduces the size of the kickback danger zone on the bar tip. A Reduced-Kickback Guide Bar has been demonstrated to significantly reduce the number and seriousness of kickbacks.

Reduced Kickback Symmetrical Guide Bar

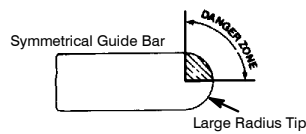
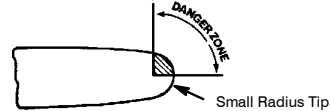

- Low-Kickback Chain, designed with a contoured depth gauge and guard link which deflect kickback force and allow wood to gradually ride into the cutter.

Low-Kickback Chain

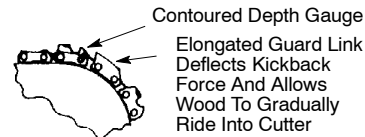

- Handguard, designed to reduce the chance of your left hand contacting the chain if your hand slips off the front handlebar.
- Position of front and rear handlebars, designed with distance between handles and "in-line" with each other. The spread and "in-line" position of the hands provided by this design work together to give balance and resistance in controlling the pivot of the saw back toward the operator if kickback occurs.

⚠ WARNING: DO NOT RELY UPON ANY OF THE DEVICES BUILT INTO YOUR SAW. YOU SHOULD USE THE SAW PROPERLY AND CAREFULLY TO AVOID KICKBACK. Reduced-kickback guide bars and low-kickback saw chains reduce the chance and magnitude of kickback and are recommended. Your saw has a low kickback chain and bar as original equipment.

Repairs on a chain brake should be made by an authorized servicing dealer. Take your unit to the place of purchase if purchased from a servicing dealer, or to the nearest authorized master service dealer.

- Tip contact in some cases may cause a lightning fast reverse REACTION, kicking the guide bar up and back toward the operator.
- Pinching the saw chain along the top of the guide bar may push the guide bar rapidly back toward the operator.
- Either of these reactions may cause you to lose control of the saw which could result in serious injury. Do not rely exclusively upon the safety devices built into your saw.

CHAIN BRAKE

- Chain brake, designed to stop the chain in the event of kickback.

WARNING: Your chain saw is equipped with a chain brake that is designed to stop the chain immediately if you get a kickback. The chain brake reduces the risk

of accidents, but only you can prevent them. **DO NOT ASSUME THAT THE CHAIN BRAKE WILL PROTECT YOU IN THE EVENT OF A KICKBACK.**

SAFETY NOTICE: Exposure to vibrations through prolonged use of gasoline powered hand tools could cause blood vessel or nerve damage in the fingers, hands, and joints of people prone to circulation disorders or abnormal swellings. Prolonged use in cold weather has been linked to blood vessel damage in otherwise healthy people. If symptoms occur such as numbness, pain, loss of strength, change in skin color or texture, or loss of feeling in the fingers, hands, or joints, discontinue the use of this tool and seek medical attention. An anti-vibration system does not guarantee the avoidance of these problems. Users who operate power tools on a continual and regular basis must monitor closely their physical condition and the condition of this tool.

ASSEMBLY

Protective gloves (not provided) should be worn during assembly.

ATTACHING THE BUMPER SPIKE

The bumper spike may be used as a pivot when making a cut.

1. Loosen and remove the chain brake nuts and the chain brake from the saw.
2. Attach the bumper spike with the two screws as illustrated.

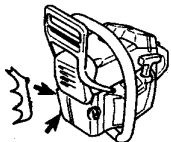

ATTACHING THE BAR & CHAIN (if not already attached)

WARNING: Recheck each assembly step if the saw is received assembled. Always wear gloves when handling the chain. The chain is sharp and can cut you even when it is not moving!

1. Loosen and remove the chain brake nuts and the chain brake from the saw.
2. Remove the plastic shipping spacer (if present).

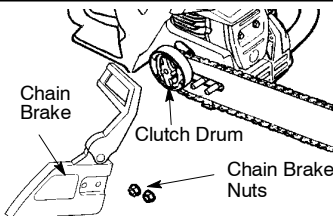

3. An adjusting pin and screw is used to adjust the tension of the chain. It is very important when assembling the bar, that the pin located on the adjusting screw aligns into a hole in the bar. Turning the screw will move the adjustment pin up and down the screw. Locate this adjustment before you begin mounting the bar onto the saw. See illustration below.

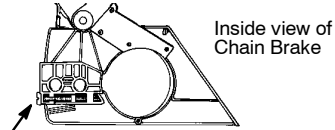

Adjustment located on Chain Brake

4. Turn the adjusting screw by hand counterclockwise until the adjusting pin just touches the stop. This should allow the pin to be near the correct position.
5. Slide guide bar behind clutch drum until guide bar stops against clutch drum sprocket.

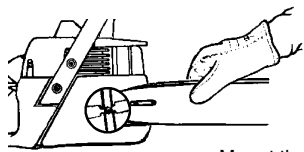

Mount the Bar

- Carefully remove the chain from the package. Hold chain with the drive links as shown.

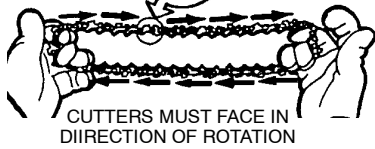

CUTTERS MUST FACE IN DIRECTION OF ROTATION

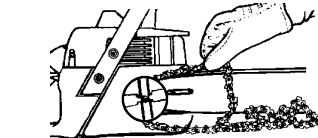
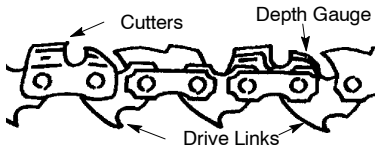

Place chain onto the sprocket

- Place chain over and behind clutch, fitting the drive links in the clutch drum sprocket.
- Fit bottom of drive links between the teeth in the sprocket in the nose of the guide bar.
- Fit chain drive links into bar groove.
- Pull guide bar forward until chain is snug in guide bar groove. Ensure all drive links are in the bar groove.
- Now, install chain brake making sure the adjusting pin is positioned in the lower hole in the guide bar. Remember this pin moves the bar forward and backward as the screw is turned.
- Install chain brake nuts and finger tighten only. Once the chain is tensioned, you will need to tighten chain brake nuts.

CHAIN TENSION (Including units with chain already installed)

NOTE: When adjusting chain tension, make sure the chain brake nuts are finger tight only. Attempting to tension the chain when the chain brake nuts are tight can cause damage.

Checking the tension:

Use the screwdriver end of the chain adjustment tool (bar tool) to move the chain around the bar. If the chain does not rotate, it is too tight. If too loose, the chain will sag below the bar.

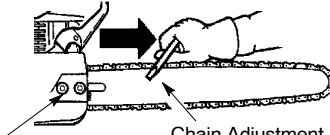

Chain Brake Nuts Chain Adjustment Tool (Bar Tool)

Adjusting the tension:

Chain tension is very important. Chain stretches during use. This is especially true during the first few times you use your saw. Always check chain tension each time you use and refuel your saw. You can adjust the chain tension by loosening the chain brake nuts and turning the adjusting screw 1/4 of a turn while lifting up on the bar.

- If chain is too tight, turn adjusting screw 1/4 turn counterclockwise.
- If chain is too loose, turn adjusting screw 1/4 turn clockwise.

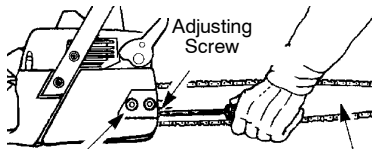

Chain Brake Nuts Adjusting Screw Guide Bar

Adjusting Screw - 1/4 Turn



- Lift up the tip of the bar and securely tighten the chain brake nuts with the bar tool.
- Recheck chain tension.

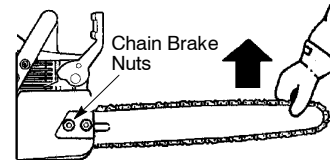

Chain Brake Nuts

WARNING: If the saw is operated with a loose chain, the chain could jump off the guide bar and result in serious injury.

WARNING: Muffler is very hot during and after use. Do not touch the muffler or allow combustible material such as dry grass or fuel to do so.

OPERATING YOUR UNIT

BEFORE STARTING ENGINE

⚠ WARNING: Be sure to read the fuel information in the safety rules before you begin. If you do not understand the safety rules, do not attempt to fuel your unit. Contact an authorized service dealer.

BAR AND CHAIN LUBRICATION

The bar and chain require continuous lubrication. Lubrication is provided by the automatic oiler system when the oil tank is kept filled. Lack of oil will quickly ruin the bar and chain. Too little oil will cause overheating shown by smoke coming from the chain and/or discoloration of the bar. Only use Bar and Chain Oil for bar and chain lubrication.

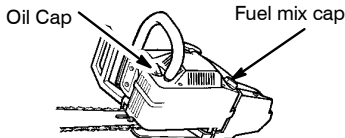

FUELING ENGINE

⚠ WARNING: Remove fuel cap slowly when refueling.

This engine is certified to operate on unleaded gasoline. Before operation, gasoline must be mixed with a good quality 2-cycle air-cooled engine oil designed to be mixed at a ratio of 40:1. A 40:1 ratio is obtained by mixing 0,125 liter of oil with 5 liters of unleaded gasoline. DO NOT USE automotive or boat oil. These oils will cause engine damage. When mixing fuel follow the instructions printed on the container. Always read and follow the safety rules relating to fuel before fueling your unit.

IMPORTANT

Experience indicates that alcohol blended fuels (called gasohol or using ethanol or methanol) can attract moisture which leads to separation and formation of acids during storage. Acidic gas can damage the fuel system of an engine while in storage. To avoid engine problems, empty the fuel system before storage for 30 days or longer. Drain the gas tank, start the engine and let it run until the fuel lines and carburetor are empty. Use fresh fuel next season. Never use engine or carburetor cleaner products in the fuel tank or permanent damage may occur.

CHAIN BRAKE

Ensure chain brake is disengaged by pulling the front hand guard back toward the front handle as far as possible. The chain brake must be disengaged before cutting with the saw.

⚠ WARNING: The chain must not move when the engine runs at idle speed. If the chain moves at idle speed refer to CARBURETOR ADJUSTMENT within this manual. Avoid contact with the muffler. A hot muffler can cause serious burns.

To stop the engine, move the ON/STOP switch to the STOP position.

To start the engine, hold the saw firmly on the ground as illustrated below. Make sure the chain is free to turn without contacting any object.

Use only 40–45 cm of rope per pull.

Hold saw firmly while pulling starter rope.

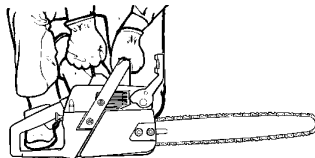

IMPORTANT POINTS TO REMEMBER

When pulling the starter rope, do not use the full extent of the rope as this can cause the rope to break. Do not let starter rope snap back. Hold the handle and let the rope rewind slowly.

For cold weather starting, start the unit at full choke; allow the engine to warm up before squeezing the throttle trigger.

NOTE: Do not cut material with the choke/fast idle lever at the FULL CHOKE position.

STARTING A COLD ENGINE (or a warm engine after running out of fuel)

NOTE: In the following steps, when the choke/fast idle lever is pulled out to the full extent, the correct throttle setting for starting is set automatically.

ON/STOP SWITCH (SIDE VIEW)

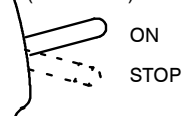

1. Move ON/STOP switch to the ON position.
2. Pull out choke/fast idle to the full extent (to the FULL CHOKE position).
3. Slowly press primer bulb 6 times.
4. Pull the starter rope sharply 5 times with your right hand. Then, proceed to the next step.

NOTE: If the engine sounds as if it is trying to start before the 5th pull, stop pulling and immediately proceed to the next step.

5. Push the choke/fast idle lever in to the HALF CHOKE position.

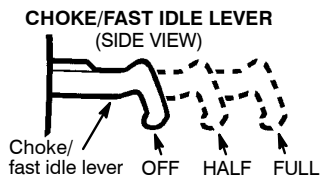

6. Pull the starter rope sharply with your right hand until the engine starts.
7. Allow the engine to run for approximately 30 seconds. Then, squeeze and release throttle trigger to allow engine to return to idle speed.

STARTING A WARM ENGINE

1. Move ON/STOP switch to the ON position.
2. Pull the choke/fast idle lever out to the HALF CHOKE position.
3. Slowly press the primer bulb 6 times.
4. Pull the starter rope sharply with your right hand until the engine starts.
5. Squeeze and release throttle trigger to allow engine to return to idle speed.

DIFFICULT STARTING (or starting a flooded engine)

The engine may be flooded with too much fuel if it has not started after 10 pulls. Flooded engines can be cleared of excess fuel by pushing the choke/fast idle lever in completely (to the OFF CHOKE position) and then following the warm engine starting procedure listed above. Ensure the ON/STOP switch is in the ON position. Starting could require pulling the starter rope handle many times depending on how badly the unit is flooded. If engine fails to start, refer to the TROUBLESHOOTING TABLE.

CHAIN BRAKE

WARNING: If the brake band is worn too thin it may break when the chain brake is triggered. With a broken brake band, the chain brake will not stop the chain. The chain brake should be replaced by an authorized service dealer if any part is worn to less than 0,02" (0,5 mm) thick. Repairs on a chain brake should be made by an authorized service dealer. Take your unit to the place of purchase if purchased from a servicing dealer,

or to the nearest authorized master service dealer.

- This saw is equipped with a chain brake. The brake is designed to stop the chain if kickback occurs.
- The inertia activated chain brake is activated if the front hand guard is pushed forward, either manually or by centrifugal force.
- If the brake is already activated, it is disengaged by pulling the front hand guard back toward the front handle as far as possible.
- When cutting with the saw, the chain brake must be disengaged.

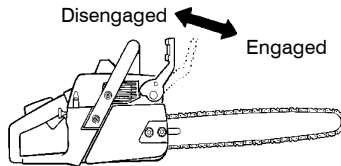

Braking function control

CAUTION: The chain brake must be checked several times daily. The engine must be running when performing this procedure. This is the only instance when the saw should be placed on the ground with the engine running.

Place the saw on firm ground. Grip the rear handle with your right hand and the front handle with your left hand. Apply full throttle by fully depressing the throttle trigger. Activate the chain brake by turning your left wrist against the hand guard without releasing your grip around the front handle. The chain should stop immediately.

Inertia activating function control

WARNING: When performing the following procedure, the engine must be turned off.

Grip the rear handle with your right hand and the front handle with your left hand. Hold the chain saw approximately 14" (35 cm) above a stump or other wooden surface. Release your grip on the front handle and use the weight of the saw to let the top of the guide bar fall forward and contact the stump. When the tip of the bar hits the stump, the brake should activate.

CUTTING METHODS

IMPORTANT POINTS

- Check chain tension before first use and after 1 minute of operation. See CHAIN TENSION in the ASSEMBLY section.
- Cut wood only. Do not cut metal, plastics, masonry, non-wood building materials, etc.
- Stop the saw if the chain strikes a foreign object. Inspect the saw and repair parts as necessary.
- Keep the chain out of dirt and sand. Even a small amount of dirt will quickly dull a chain and increase the possibility of kickback.

- Practice cutting a few small logs using the following techniques to get the "feel" of using your saw before you begin a major sawing operation.
 - Squeeze the throttle trigger and allow the engine to reach full speed before cutting.
 - Begin cutting with the saw frame against the log.
 - Keep the engine at full speed the entire time you are cutting.
 - Allow the chain to cut for you. Exert only light downward pressure.

- Release the throttle trigger as soon as the cut is completed, allowing the engine to idle. If you run the saw at full throttle without a cutting load, unnecessary wear can occur.
- To avoid losing control when cut is complete, do not put pressure on saw at end of cut.
- Stop the engine before setting the saw down.

TREE FELLING TECHNIQUES

⚠ WARNING: Do not cut near buildings or electrical wires if you do not know the direction of tree fall, at night since you will not be able to see well, or during bad weather such as rain, snow, or strong winds, as fall is unpredictable.

Carefully plan your sawing operation in advance. You need a clear area all around the tree so you can have secure footing. Check for broken or dead branches which can fall on you causing serious injury.

Natural conditions that can cause a tree to fall in a particular direction include:

- The wind direction and speed.
- The lean of the tree. The lean of a tree might not be apparent due to uneven or sloping terrain. Use a plumb or level to determine the direction of tree lean.
- Weight and branches on one side.
- Surrounding trees and obstacles.

Look for decay and rot. If the trunk is rotted, it can snap and fall toward the operator. Make sure there is enough room for the tree to fall. Maintain a distance of 2-1/2 tree lengths from the nearest person or other objects. Engine noise can drown out a warning call. Remove dirt, stones, loose bark, nails, staples, and wire from the tree where cuts are to be made.

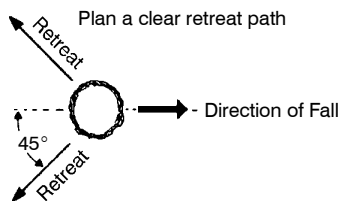

FELLING LARGE TREES

(15 cm in diameter or larger)

The notch method is used to fell large trees. A notch is cut on the side of the tree in the desired direction of fall. After a felling cut is made on the opposite side of tree, the tree will tend to fall into the notch.

NOTCH CUT AND FELLING THE TREE

- Make notch cut by cutting the top of the notch first. Cut through 1/3 of the diameter of the tree. Next complete the notch by cutting the bottom of the notch. See illustration. Once the notch is cut remove the notch of wood from the tree.

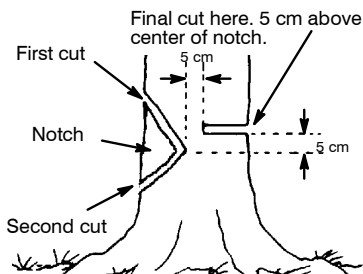

- After removing the wood from the notch, make the felling cut on the opposite side of the notch. This is done by making a cut about two inches higher than the center of the notch. This will leave enough uncut wood between the felling cut and the notch to form a hinge. This hinge will help prevent the tree from falling in the wrong direction. Hinge holds tree on stump and helps control fall

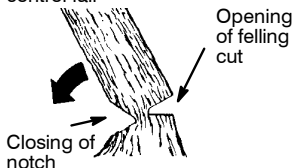

NOTE: Before felling cut is complete, use wedges to open the cut when necessary to control the direction of fall. To avoid kickback or chain damage, use wood or plastic wedges, but never steel or iron wedges.

- Be alert to signs that the tree is ready to fall: cracking sounds, widening of the felling cut, or movement in the upper branches.
- As tree starts to fall, stop saw, put it down, and get away quickly on your planned retreat path.
- DO NOT cut down a partially fallen tree with your saw. Be extremely cautious with partially fallen trees that may be poorly supported. When a tree doesn't fall completely, set the saw aside and pull down the tree with a cable winch, block and tackle, or tractor.

CUTTING A FALLEN TREE (BUCKING)

Bucking is the term used for cutting a fallen tree to the desired log length.

⚠ WARNING: Do not stand on the log being cut. Any portion can roll causing loss of footing and control. Do not stand downhill of the log being cut.

Important points

- Cut only one log at a time.
- Cut shattered wood very carefully; sharp pieces of wood could be flung toward operator.
- Use a sawhorse to cut small logs. Never allow another person to hold the log while cutting and never hold the log with your leg or foot.

- Do not cut in an area where logs, limbs, and roots are tangled. Drag the logs into a clear area before cutting by pulling out exposed and cleared logs first.

TYPES OF CUTTING USED FOR BUCKING

⚠ WARNING: If saw becomes pinched or hung in a log, don't try to force it out. You can lose control of the saw resulting in injury and/or damage to the saw. Stop the saw, drive a wedge of plastic or wood into the cut until the saw can be removed easily. Restart the saw and carefully reenter the cut. Do not attempt to restart your saw when it is pinched or hung in a log.

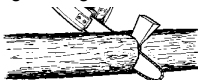

Turn saw **OFF** and use a plastic or wooden wedge to force cut open.

Overcutting begins on the top side of the log with the saw against the log. When overcutting use light downward pressure.

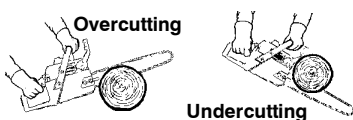

Undercutting involves cutting on the underside of the log with top of saw against the log. When undercutting use light upward pressure. Hold saw firmly and maintain control. The saw will tend to push back toward you.

⚠ WARNING: Never turn saw upside down to undercut. The saw cannot be controlled in this position.

First cut on pressure side of log

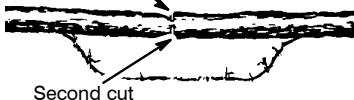

Second cut

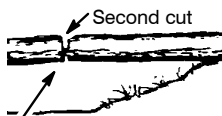

First cut on pressure side of log

BUCKING WITHOUT A SUPPORT

- Overcut through 1/3 of the diameter of the log.
- Roll the log over and finish with a second overcut.
- Give special attention to logs under strain to prevent the saw from pinching. Make the first cut on the pressure side to relieve the stress on the log.

BUCKING USING A LOG OR SUPPORT STAND

- Remember your first cut is always on the pressure side of the log.
- Your first cut should extend 1/3 of the diameter of the log.
- Finish with your second cut.

Using a log for support

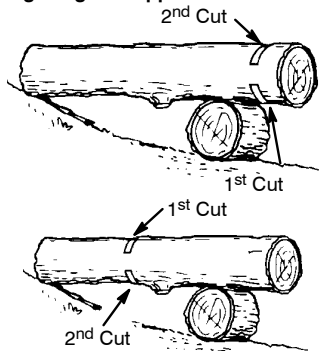

Using a support stand

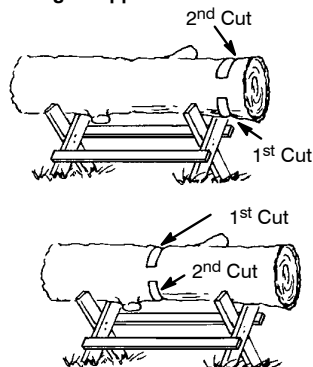

LIMBING AND PRUNING

⚠ WARNING: Be alert for and guard against kickback. Do not allow the moving chain to contact any other branched or objects at the nose of the guide bar when limbing or pruning. Allowing such contact can result in serious injury.

⚠ WARNING: Never climb into a tree to limb or prune. Do not stand on ladders, platforms, a log, or in any position which can cause you to lose your balance or control of the saw.

IMPORTANT POINTS

- Watch out for springpoles. Use extreme caution when cutting small size limbs. Slender material may catch the saw chain and be whipped toward you or pull you off balance.
- Be alert for springback. Watch out for branches that are bent or under pressure. Avoid being struck by the branch or the saw when the tension in the wood fibers is released.

- Keep a clear work area. Frequently clear branches out of the way to avoid tripping over them.

LIMBING

- Always limb a tree after it is cut down. Only then can limbing be done safely and properly.
- Leave the larger limbs underneath the felled tree to support the tree as you work.
- Start at base of the felled tree and work toward the top, cutting branches and limbs. Remove small limbs with one cut.
- Keep the tree between you and the chain saw as much as possible.
- Remove larger, supporting branches with the cutting techniques described in BUCKING WITHOUT A SUPPORT.
- Always use an overcut to cut small and freely hanging limbs. Undercutting could cause limbs to fall and pinch saw.

PRUNING

⚠ WARNING: Limit pruning to limbs shoulder height or below. Do not cut if branches are higher than your shoulder. Get a professional to do the job.

- Make your first cut 1/3 of the way through the bottom of the limb.
- Next make a 2nd cut **all the way through the limb**. Then cut a third overcut leaving a 1 to 2 inch collar from the trunk of the tree.

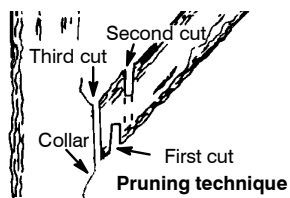

SERVICE AND ADJUSTMENTS

⚠ WARNING: Disconnect the spark plug before performing maintenance, except for carburetor adjustments.

We recommend all service and adjustments not listed in this manual be performed by an Authorized Service Dealer.

MAINTENANCE SCHEDULE	
Check:	
Fuel mixture level	Before each use
Bar lubrication	Before each use
Chain tension	Before each use
Chain sharpness	Before each use
For damaged parts	Before each use
For loose caps	Before each use
For loose fasteners	Before each use
For loose parts	Before each use
Inspect and Clean:	
Bar	Before each use
Complete saw	After each use
Air filter	Every 5 hours*
Chain brake	Every 5 hours*
Spark arresting screen and muffler	Every 25 hours*
Replace spark plug	Yearly
Replace fuel filter	Yearly
* Hours of Operation	

AIR FILTER

⚠ CAUTION: Do not clean filter in gasoline or other flammable solvent to avoid creating a fire hazard or producing harmful evaporative emissions.

Cleaning the air filter:

A dirty air filter decreases engine performance and increases fuel consumption and harmful emissions. Always clean after every 5 hours of operation.

1. Clean the cover and the area around it to keep dirt and sawdust from falling into the carburetor chamber when the cover is removed.

2. Remove the parts as illustrated below.
3. Wash the filter in soap and water. Rinse in clean cool water. Air dry completely before reinstalling.
4. Add a few drops of oil to the filter; squeeze filter to distribute oil.
5. Reinstall parts.

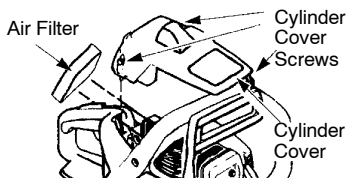

BAR MAINTENANCE

If your saw cuts to one side, has to be forced through the cut, or been run with an improper amount of bar lubrication it may be necessary to service your bar. A worn bar will damage your chain and make cutting difficult.

After each use, ensure ON/STOP switch is in the STOP position, then clean all sawdust from the guide bar and sprocket hole.

To maintain guide bar:

- Move ON/STOP switch to the STOP position.
- Loosen and remove chain brake nuts and chain brake. Remove bar and chain from saw.
- Clean the oil holes and bar groove after each 5 hours of operation.

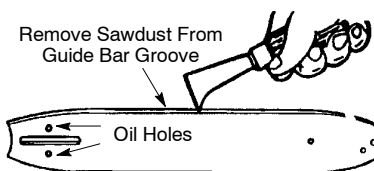

- Burring of guide bar rails is a normal process of rail wear. Remove these burrs with a flat file.
- When rail top is uneven, use a flat file to restore square edges and sides.

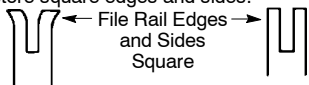

Worn Groove **Correct Groove**
 Replace guide bar when the groove is worn, the guide bar is bent or cracked, or when excess heating or burring of the rails occurs. If replacement is necessary, use only the guide bar specified for your saw in the repair parts list or on the decal located on the chain saw.

SPARK PLUG

The spark plug should be replaced each year to ensure the engine starts easier and runs better. Ignition timing is fixed and non-adjustable.

1. Loosen 3 screws on cylinder cover.
2. Remove the cylinder cover.
3. Pull off the spark plug boot.
4. Remove spark plug from cylinder and discard.
5. Replace with Champion RCJ-7Y spark plug and tighten securely with a 19 mm socket wrench. Spark plug gap should be 0,5 mm.
6. Reinstall the spark plug boot.
7. Reinstall the cylinder cover and 3 screws. Tighten securely.

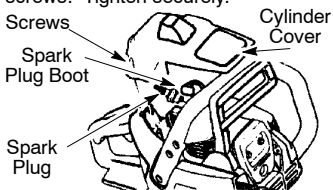

CHAIN SHARPENING

Chain sharpening is a complicated task that requires special tools. We recommend that you refer chain sharpening to a professional chain sharpener.

CARBURETOR ADJUSTMENT

WARNING: The chain will be moving during most of this procedure. Wear your protective equipment and observe all safety precautions. The chain must not move at idle speed.

The carburetor has been carefully set at the factory. Adjustments may be necessary if you notice any of the following conditions:

- Chain moves at idle. See IDLE SPEED-T adjusting procedure.
- Saw will not idle. See IDLE SPEED-T adjusting procedure.

Idle Speed-T

Allow engine to idle. If the chain moves, idle is too fast. If the engine stalls, idle is too slow. Adjust speed until engine runs without chain movement (idle too fast) or stalling (idle too slow). The idle speed screw is located in the area above the primer bulb and is labeled T.

- Turn idle speed screw (T) clockwise to increase engine speed.
- Turn idle speed screw (T) counterclockwise to decrease engine speed.

STORAGE

WARNING: Stop engine and allow to cool, and secure the unit before storing or transporting in a vehicle. Store unit and fuel in an area where fuel vapors cannot reach sparks or open flames from water heaters, electric motors or switches, furnaces, etc. Store unit with all guards in place. Position so that any sharp object cannot accidentally cause injury to passersby. Store the unit out of reach of children.

- Before storing, drain all fuel from the unit. Start engine and allow to run until it stops.
- Clean the unit before storing. Pay particular attention to the air intake area, keeping it free of debris. Use a mild detergent and sponge to clean the plastic surfaces.
- Do not store the unit or fuel in a closed area where fuel vapors can reach sparks or an open flame from hot water heaters, electric motors or switches, furnaces, etc.
- Store in a dry area out of the reach of children.

CAUTION: It is important to prevent gum deposits from forming in essential fuel system parts such as the carburetor, fuel filter, fuel hose, or fuel tank during storage. Alcohol blended fuels (called gasohol or using ethanol or methanol) can attract moisture which leads to fuel mixture separation and formation of acids during storage. Acidic gas can damage the engine.

TROUBLESHOOTING TABLE

⚠ WARNING: Always stop unit and disconnect spark plug before performing all of the recommended remedies below except remedies that require operation of the unit.

TROUBLE	CAUSE	REMEDY
Engine will not start or will run only a few seconds after starting.	<ol style="list-style-type: none">1. Ignition switch off.2. Engine flooded.3. Fuel tank empty.4. Spark plug not firing.5. Fuel not reaching carburetor.	<ol style="list-style-type: none">1. Move ignition switch to ON.2. See "Difficult Starting" in Operation Section.3. Fill tank with correct fuel mixture.4. Install new spark plug.5. Check for dirty fuel filter; replace. Check for kinked or split fuel line; repair or replace.
Engine will not idle properly.	<ol style="list-style-type: none">1. Idle speed requires adjustment.2. Carburetor requires adjustment.	<ol style="list-style-type: none">1. See "Carburetor Adjustment" in the Service and Adjustments Section.2. Contact an authorized service dealer.
Engine will not accelerate, lacks power, or dies under a load.	<ol style="list-style-type: none">1. Air filter dirty.2. Spark plug fouled.3. Chain brake engaged.4. Carburetor requires adjustment.	<ol style="list-style-type: none">1. Clean or replace air filter.2. Clean or replace plug and regap.3. Disengage chain brake.4. Contact an authorized service dealer.
Engine smokes excessively.	<ol style="list-style-type: none">1. Too much oil mixed with gasoline.	<ol style="list-style-type: none">1. Empty fuel tank and refill with correct fuel mixture.
Chain moves at idle speed.	<ol style="list-style-type: none">1. Idle speed requires adjustment.2. Clutch requires repair.	<ol style="list-style-type: none">1. See "Carburetor Adjustment" in the Service and Adjustments Section.2. Contact an authorized service dealer.

TECHNICAL DATA SHEET

MODEL: PP3440

ENGINE

Cylinder volume, cm ³	34
Stroke, mm	32
Idle speed, rpm	3,000
Recommended max speed, unloaded, rpm	13,000
Power, kW	1,2

IGNITION SYSTEM

Manufacturer	Walbro
Type of ignition system	CD
Spark plug	Champion
Electrode gap, mm	0,5

FUEL AND LUBRICATION SYSTEM

Manufacturer	Walbro
Carburetor type	WT-662
Fuel capacity, litre	0,38
Oil pump capacity at 8,500 rpm ml/min	4 - 8
Oil capacity, litre	0,2
Type of oil pump	Automatic

WEIGHT

Without bar and chain, kg	4,7
---------------------------	-----







NOISE LEVELS (See note 1)

Equivalent noise pressure level at operator's ear, measured according to relevant international standards, dB(A)	103
Equivalent noise power level, measured according to relevant international standards, dB(A)	111
Recommended limit of usage a day, minutes (SanPiN 2.2.2.540-96)	152

CHAIN/BAR

Standard bar length, inches/cm	16/40
Recommended bar length, inches/cm	16/40
Usable cutting length, inches/cm	15,5/39
Chain speed at max. power, m/sec	18,5
Pitch, cm	0,952
Thickness of drive link, mm	1,27
Number of teeth on drive sprocket	6
Maximum Bar Tip Radius	7T
Chain type	Oregon 91VJ/VG

Note 1: Equivalent noise level is, according to ISO 22868, calculated as the time-weighted energy total for noise levels under various working conditions with the following time distribution 1/3 idle, 1/3 full load, 1/3 full speed.

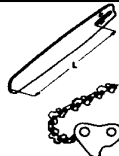
								
Type	Inch	Inch/mm	Inch/mm	Degree°	Degree°	Degree°	Inch/mm	Inch/mm - dl
91VJ	0,375	0,050/1,3	5/32 / 4,0	85°	30°	0°	0,025/0,65	16/40:56
91VG	0,375	0,050/1,3	5/32 / 4,0	85°	30°	0°	0,025/0,65	16/40:56

ADDRESS: Husqvarna Outdoor Products Italia S.p.A.
Via Como 72
Valmadrera, Lecco
ITALY I-23868

STATEMENT OF WARRANTY

Husqvarna Outdoor Products provides warranty to the initial purchaser for all products that are sold by an authorised Husqvarna Outdoor Products Dealer.

The warranty provides the purchaser with a guarantee against faulty workmanship in manufacture and/or defective components. If any product supplied by Husqvarna Outdoor Products is found to be defective due to faulty manufacture within the warranty period, Husqvarna Outdoor Products through its Authorised Servicing Dealers will effect the repair or replacement at their discretion to the customer, free of charge providing;

- The fault is reported directly to the Authorised Servicing Dealer.
- Proof of purchase is provided.
- The fault is not caused by misuse, neglect or faulty adjustment by the user.
- The failure has not occurred through normal wear and tear.
- The product has not been serviced, repaired or alterations made by any person not authorised by Husqvarna Outdoor Products.
- The machine has not been used for hire.

Nothing contained in this warranty is intended to purport to restrict, modify or exclude the operation of any legislation in the State where the product was purchased. The following items are not covered by this warranty:

- Normal customer maintenance items which become worn through normal regular use, including, but not limited to, belts, blades, blade adapters, globes, filters, guide bars, lubricants, rewind springs, saw chain, spark plugs, starter ropes, and tines;
- Natural discolouration of material due to ultraviolet light;
- Engine and drive systems not manufactured by Husqvarna Outdoor Products, these items are covered by the respective original equipment manufacturers warranty, all claims must be sent to the appropriate manufacturer.

Product Warranty Period	Domestic	Commercial
	Non-Powered Push Mowers	12 Months
Electric and Petrol Walk-Behind Mowers	12 Months	90 Days
Electric and Petrol Chainsaws	12 Months	90 Days
Electric and Petrol Trimmers	12 Months	90 Days
Electric and Petrol Blowers	12 Months	90 Days
Petrol Ride-on Mowers	12 Months	90 Days