

LIMITED WARRANTY

The Manufacturer warrants to the original consumer purchaser that this product as manufactured is free from defects in materials and workmanship. For a period of two (2) years from date of purchase by the original consumer purchaser, we will repair or replace, at our option, without charge for parts or labor incurred in replacing parts, any part which we find to be defective due to materials or workmanship. This Warranty is subject to the following limitations and exclusions.

1. This warranty does not apply to the engine, transaxle/transmission components, battery (except as noted below) or components parts thereof. Please refer to the applicable manufacturer's warranty on these items.
2. Transportation charges for the movement of any power equipment unit or attachment are the responsibility of the purchaser. Transportation charges for any parts submitted for replacement under this warranty must be paid by the purchaser unless such return is requested by the manufacturer.
3. Battery Warranty: On products equipped with a Battery, we will replace, without charge to you, any battery which we find to be defective in manufacture, during the first ninety (90) days of ownership. After ninety (90) days, we will exchange the Battery, charging you 1/12 of the price of a new Battery for each full month from the date of the original sale. Battery must be maintained in accordance with the instructions furnished.
4. The Warranty period for any products used for rental or commercial purposes is limited to 45 days from the date of original purchase.
5. This Warranty applies only to products which have been properly assembled, adjusted, operated, and maintained in accordance with the instructions furnished. This Warranty does not apply to any product which has been subjected to alteration, misuse, abuse, improper assembly or installation, delivery damage, or to normal wear of the product.
6. Exclusions: Excluded from this Warranty are belts, blades, blade adapters, normal wear, normal adjustments, standard hardware and normal maintenance.
7. In the event you have a claim under this Warranty, you must return the product to an authorized service dealer.

Should you have any unanswered questions concerning this Warranty, contact:

Poulan Pro
Customer Service Department
9335 Harris Corners Parkway
Charlotte, NC 28269 USA

In Canada contact:
Poulan Pro
Customer Service Department
5855 Terry Fox Way
Mississauga, Ontario L5V 3E4

giving the model number, serial number and date of purchase of your product and the name and address of the authorized dealer from whom it was purchased.

THIS WARRANTY DOES NOT APPLY TO INCIDENTAL OR CONSEQUENTIAL DAMAGES AND ANY IMPLIED WARRANTIES ARE LIMITED TO THE SAME TIME PERIODS STATED HEREIN FOR OUR EXPRESSED WARRANTIES.

Some areas do not allow the limitation of consequential damages or limitations of how long an implied Warranty may last, so the above limitations or exclusions may not apply to you. This Warranty gives you specific legal rights, and you may have other rights which vary from locale to locale.

This is a limited Warranty within the meaning of that term as defined in the Magnuson-Moss Act of 1975.

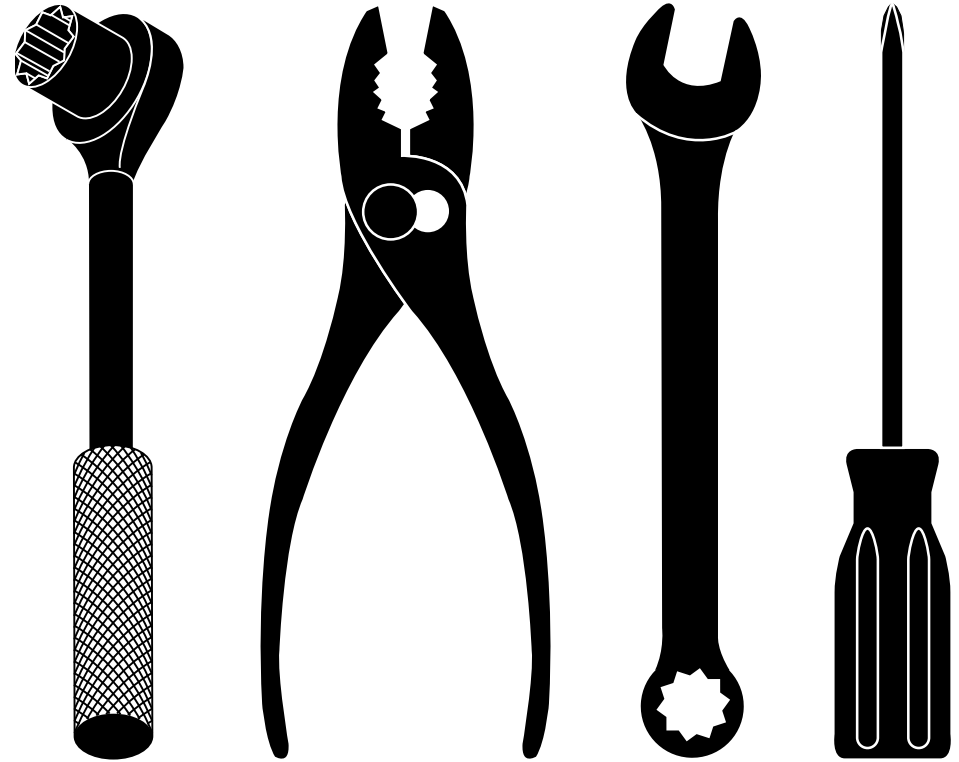

REPAIR PARTS MANUAL MODEL NO. PR500N21SH MFG. ID. NO. 96112012402 Rotary Lawn Mower

For Parts and Service or Technical Assistance, call 1-800-487-5951

Poulan PRO

NOTE: Gasoline containing up to 10% ethanol (E10) is acceptable for use in this machine. The use of any gasoline exceeding 10% ethanol (E10) will void the product warranty.

586 30 96-27 12.17.13 BY

Printed in U.S.A.

Poulan PRO

POULAN PRO ROTARY LAWN MOWER - MODEL NO. PR500N21SH (MFG. ID. NO. 96112012402)

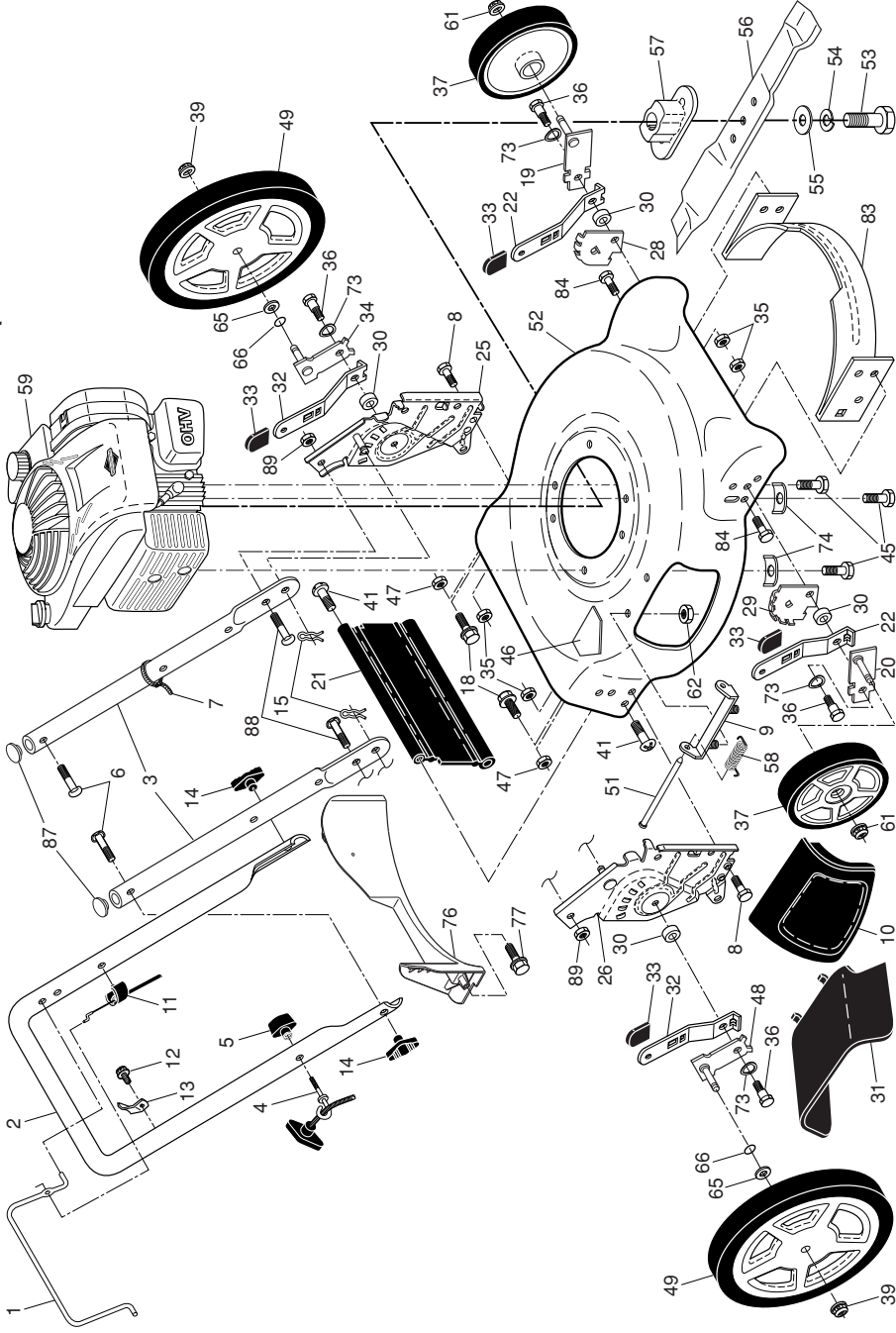

2

POULAN PRO ROTARY LAWN MOWER - MODEL NO. PR500N21SH (MFG. ID. NO. 96112012402)

KEY NO.	PART NO.	DESCRIPTION	KEY NO.	PART NO.	DESCRIPTION	KEY NO.	PART NO.	DESCRIPTION
1	532 44 73-65	Control Bar	56	532 40 67-12	21" Blade	61	532 40 91-48	Flanged Locknut
2	532 44 82-63	Upper Handle	57	581 54 79-01	Blade Adapter	62	873 80 04-00	Nut, Hex
3	580 63 86-02	Bar, Lower Handle	58	532 15 21-24	Hinge Spring	65	532 08 83-48	Washer, Flat
4	581 90 21-01	Rope Guide	59	---	Engine, Briggs & Stratton, Model Number 9P602-0063-F1 (For engine service and replacement parts, call Briggs & Stratton at 1-800-233-3723)	66	532 19 74-80	O-Ring
5	581 91 26-01	T-Knob				73	532 40 16-30	Washer, Curved, Cylindrical
6	532 19 15-74	Handle Bolt				74	532 12 50-78	Washer, Special, Engine
7	532 06 64-26	Wire Tie				76	532 41 05-89	Baffle, Rear
8	874 78 05-12	Bolt, Hex Head 5/16-18 x 3/4				77	817 41 13-12	Screw, Rear Baffle
9	532 15 41-32	Hinge Bracket				83	532 42 85-01	Baffle, Front
10	532 16 57-54	Mulcher Door				84	817 00 05-10	Screw, Hex Head 5/8-16
11	532 44 09-34	Engine Zone Control Cable				87	532 43 75-16	Plug, Handle Bar
12	532 17 88-48	Hex Washer Head Screw #10-16 x 5/8				88	872 25 05-05	Bolt, Carriage
13	532 43 00-34	Up-Stop Bracket				89	873 97 05-00	Locknut, Hex, Flanged
14	532 19 19-38	Handle Knob				--	532 40 47-64	Warning Decal (not shown)
15	532 05 17-93	Hairpin Cotter				--	115 58 77-27	Operator's Manual, English
18	817 60 04-06	Screw				--	115 58 77-31	Operator's Manual, French
19	532 40 66-89	Axle Arm Assembly, Front, LH				--	115 58 77-46	Operator's Manual, Spanish
20	532 40 66-90	Axle Arm Assembly, Front, RH				--	586 30 96-27	Repair Parts Manual
21	532 41 86-55	Kit, Rear Skirt	29	532 41 44-40	Wheel Adjusting Bracket, Front, RH			
22	532 40 64-28	Selector Spring, Front	30	532 40 16-29	Spacer			
25	580 91 56-02	Handle Bracket, LH	31	532 16 57-60	Discharge Deflector			
26	580 91 57-02	Handle Bracket, RH	32	532 44 15-59	Selector Spring, Rear			
28	532 41 44-41	Wheel Adjusting Bracket, Front, LH	33	532 08 78-77	Selector Knob			
			34	532 41 06-00	Axle Arm Assy., Rear, LH			
			35	532 42 65-89	Locknut, Hex 5/16-18			
			36	532 40 16-38	Shoulder Bolt 5/16-18			
			37	532 43 05-01	Wheel & Tire Assembly, Front 7 x 1-3/4			
			39	532 40 91-49	Nut, Hex			
			41	532 19 41-86	Screw, Hinge			
			45	532 15 04-06	Hex Head Thread Rolling Screw 3/8-16 x 1			
			46	532 40 47-63	Danger Decal			
			47	532 75 11-53	Nut, Hex			
			48	532 41 06-01	Axle Arm Assy., Rear, RH			
			49	581 01 03-22	Wheel & Tire Assembly, Rear 12 x 1-3/4			
			51	532 14 72-86	Hinge Rod			
			52	581 70 83-03	Kit, Housing (Includes #46)			
			53	532 85 10-84	Screw, Hex Head, Grade 8 3/8-24 x 1-3/8			
			54	532 85 02-63	Helical Lockwasher			
			55	532 85 10-74	Hardened Washer			

3

IMPORTANT: Use only Original Equipment Manufacturer (O.E.M.) replacement parts. Failure to do so could be hazardous, damage your lawn mower and void your warranty.

NOTE: All component dimensions given in U.S. inches. 1 inch = 25.4 mm.